

# JVC

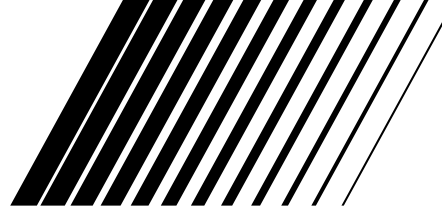

## HOME CINEMA CONTROL CENTER

# RX-E111RSL / RX-E112RSL

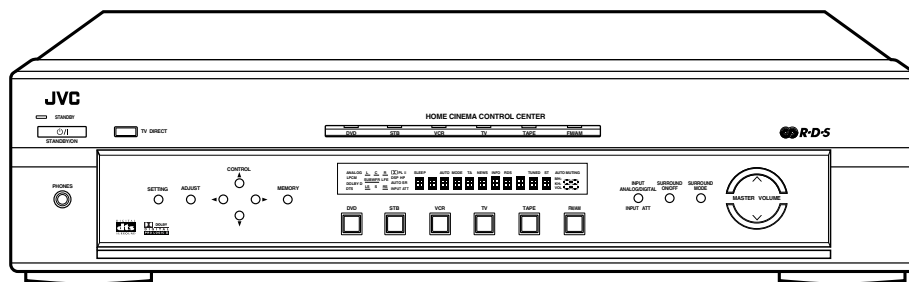
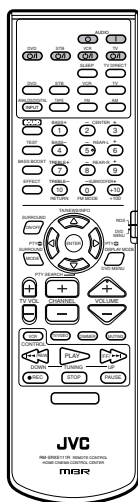

## INSTRUCTIONS

### For Customer Use:

Enter below the Model No. and Serial No. which are located either on the rear, bottom or side of the cabinet. Retain this information for future reference.

Model No. \_\_\_\_\_

Serial No. \_\_\_\_\_

LVT0858-001A

[B]

# Warnings, Cautions and Others

---

**IMPORTANT** for the U.K.

**DO NOT** cut off the mains plug from this equipment. If the plug fitted is not suitable for the power points in your home or the cable is too short to reach a power point, then obtain an appropriate safety approved extension lead or consult your dealer.

**BE SURE** to replace the fuse only with an identical approved type, as originally fitted.

If nonetheless the mains plug is cut off ensure to remove the fuse and dispose of the plug immediately, to avoid a possible shock hazard by inadvertent connection to the mains supply.

If this product is not supplied fitted with a mains plug then follow the instructions given below:

**IMPORTANT**

**DO NOT** make any connection to the terminal which is marked with the letter E or by the safety earth symbol or coloured green or green-and-yellow.

The wires in the mains lead on this product are coloured in accordance with the following code:

Blue : Neutral  
Brown : Live

As these colours may not correspond with the coloured markings identifying the terminals in your plug proceed as follows:

The wire which is coloured blue must be connected to the terminal which is marked with the letter N or coloured black.

The wire which is coloured brown must be connected to the terminal which is marked with the letter L or coloured red.

**IF IN DOUBT - CONSULT A COMPETENT ELECTRICIAN.**

**CAUTION**

To reduce the risk of electrical shocks, fire, etc.:

1. Do not remove screws, covers or cabinet.
2. Do not expose this appliance to rain or moisture.

**Caution —  switch!**

Disconnect the mains plug to shut the power off completely. The  switch in any position does not disconnect the mains line. The power can be remote controlled.

**CAUTION**

- Do not block the ventilation openings or holes.  
(If the ventilation openings or holes are blocked by a newspaper or cloth, etc., the heat may not be able to get out.)
- Do not place any naked flame sources, such as lighted candles, on the apparatus.
- When discarding batteries, environmental problems must be considered and local rules or laws governing the disposal of these batteries must be followed strictly.
- Do not expose this apparatus to rain, moisture, dripping or splashing and that no objects filled with liquids such as vases, shall be placed on the apparatus.

**Caution: Proper Ventilation**

To avoid risk of electric shock and fire and to protect from damage.

Locate the apparatus as follows:

- Front: No obstructions open spacing.
- Sides: No obstructions in 10 cm from the sides.
- Top: No obstructions in 10 cm from the top.
- Back: No obstructions in 15 cm from the back
- Bottom: No obstructions, place on the level surface.

In addition, maintain the best possible air circulation as illustrated.

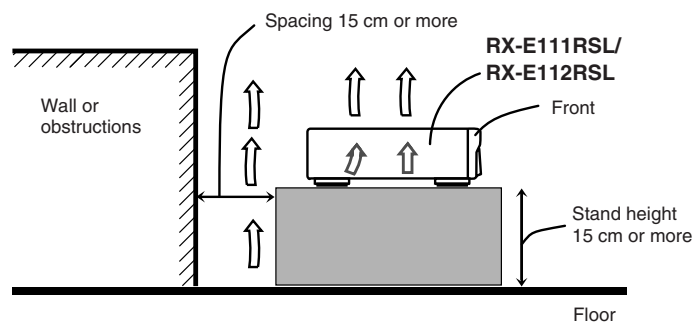

## **SAFETY INSTRUCTIONS**

### **“SOME DOS AND DON'TS ON THE SAFE USE OF EQUIPMENT”**

This equipment has been designed and manufactured to meet international safety standards but, like any electrical equipment, care must be taken if you are to obtain the best results and safety is to be assured.

\*\*\*\*\*

Do read the operating instructions before you attempt to use the equipment.

Do ensure that all electrical connections (including the mains plug, extension leads and interconnections between pieces of equipment) are properly made and in accordance with the manufacturer's instructions. Switch off and withdraw the mains plug when making or changing connections.

Do consult your dealer if you are ever in doubt about the installation, operation or safety of your equipment.

Do be careful with glass panels or doors on equipment.

\*\*\*\*\*

DON'T continue to operate the equipment if you are in any doubt about it working normally, or if it is damaged in any way—switch off, withdraw the mains plug and consult your dealer.

DON'T remove any fixed cover as this may expose dangerous voltages.

DON'T leave equipment switched on when it is unattended unless it is specifically stated that it is designed for unattended operation or has a standby mode.

Switch off using the switch on the equipment and make sure that your family know how to do this.

Special arrangements may need to be made for infirm or handicapped people.

DON'T use equipment such as personal stereos or radios so that you are distracted from the requirements of traffic safety. It is illegal to watch television whilst driving.

DON'T listen to headphones at high volume as such use can permanently damage your hearing.

DON'T obstruct the ventilation of the equipment, for example with curtains or soft furnishings.

Overheating will cause damage and shorten the life of the equipment.

DON'T use makeshift stands and NEVER fix legs with wood screws — to ensure complete safety always fit the manufacturer's approved stand or legs with the fixings provided according to the instructions.

DON'T allow electrical equipment to be exposed to rain or moisture.

ABOVE ALL

- NEVER let anyone, especially children, push anything into holes, slots or any other opening in the case -this could result in a fatal electrical shock.;
- NEVER guess or take chances with electrical equipment of any kind — it is better to be safe than sorry!

<b>Parts Identification .....</b>	<b>2</b>
<b>Getting Started .....</b>	<b>3</b>
Before Installation .....	3
Checking the Supplied Accessories .....	3
Putting Batteries in the Remote Control .....	3
Connecting the FM and AM (MW/LW) Antennas .....	4
Connecting the Speakers .....	5
Connecting Audio/Video Components .....	7
Connecting the Power Cord .....	9
<b>Basic Operations .....</b>	<b>10</b>
1 Turn On the Power .....	10
2 Select the Source to Play .....	10
3 Adjust the Volume .....	10
Activating TV Direct .....	11
Turning Off the Sounds Temporarily—Muting .....	12
Turning Off the Power with the Sleep Timer .....	12
Changing the Display Brightness .....	12
<b>Basic Settings .....</b>	<b>13</b>
Setting the Digital Input (DIGITAL IN) Terminals .....	13
Selecting the Analogue or Digital Input Mode .....	13
Setting the Subwoofer Information .....	15
Setting the Speakers Information .....	15
Setting Auto Surround .....	18
Setting the Auto Function Mode .....	19
<b>Sound Adjustments .....</b>	<b>20</b>
Attenuating the Input Signal .....	20
Adjusting the Front Speakers Output Balance .....	20
Reinforcing the Bass .....	21
Adjusting the Tone .....	21
Adjusting the Subwoofer Output Level .....	22
<b>Tuner Operations .....</b>	<b>23</b>
Tuning into Stations Manually .....	23
Using Preset Tuning .....	24
Selecting the FM Reception Mode .....	25
Using the RDS (Radio Data System) to Receive	
FM Stations .....	26
Searching for a Program by PTY Codes .....	27
Switching to Broadcast Program of	
Your Choice Temporarily .....	29
<b>Creating Realistic Sound Fields .....</b>	<b>30</b>
About Relations between Speaker Layout and	
Surround Modes .....	32
Using Dolby Pro Logic II, Dolby Digital and	
DTS Digital Surround (Remote Control) .....	33
Using DAP Modes and All Channel Stereo	
(Remote Control) .....	35
Using Dolby Pro Logic II, Dolby Digital and	
DTS Digital Surround (Front Panel) .....	36
Using DAP Modes and All Channel Stereo	
(Front Panel) .....	37
<b>Mastering Remote Operations .....</b>	<b>38</b>
<b>Troubleshooting .....</b>	<b>43</b>
<b>Specifications .....</b>	<b>45</b>



This mark indicates that the remote control CAN ONLY be used for the operation explained.



This mark indicates that the remote control CANNOT be used for the operation explained. Use buttons on the front panel.

# Parts Identification

## Front Panel

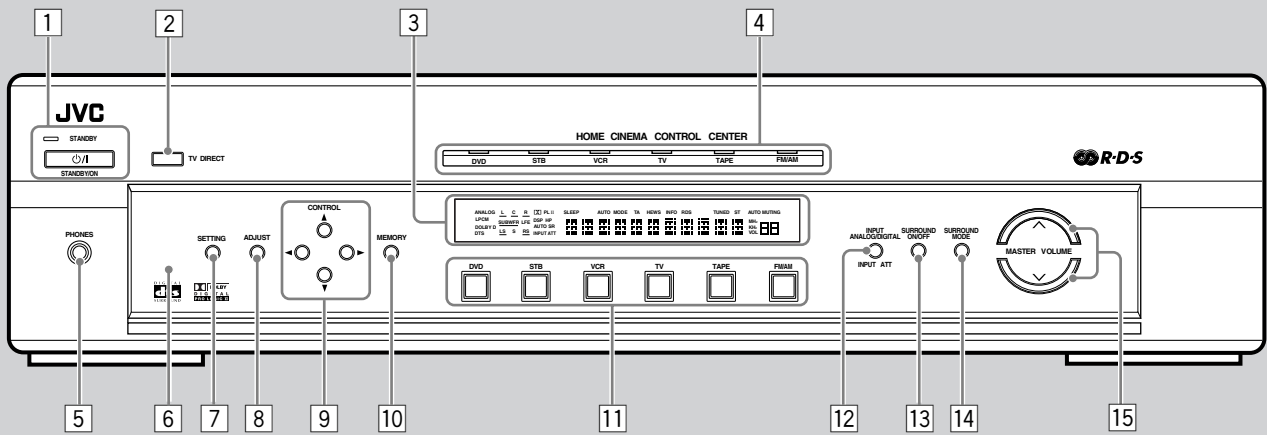

## Remote Control

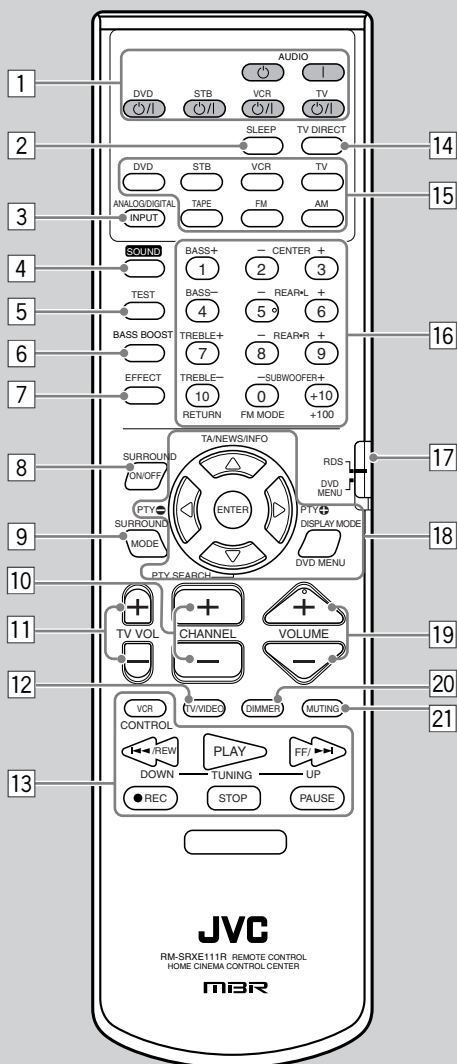

See pages in the parentheses for details.

### Front Panel

- 1 STANDBY/ON button and STANDBY lamp (10)
- 2 TV DIRECT button (11)
- 3 Display
- 4 Source indicators
- 5 PHONES jack (10)
- 6 Remote sensor
- 7 SETTING button (13, 15 – 19)
- 8 ADJUST button (20 – 22, 36, 37)
- 9 CONTROL buttons (13 – 25, 36, 37)
- 10 MEMORY button (24)
- 11 Source selecting buttons (10, 11, 13, 23, 25)  
DVD, STB, VCR, TV, TAPE, FM/AM
- 12 INPUT ANALOG/DIGITAL button (13)  
INPUT ATT button (20)
- 13 SURROUND ON/OFF button (32, 36, 37)
- 14 SURROUND MODE button (32, 36, 37)
- 15 MASTER VOLUME buttons (10)

### Remote Control

- 1 Standby/on buttons (10, 38, 39)  
AUDIO , AUDIO , DVD , STB , VCR , TV
- 2 SLEEP button (12, 38)
- 3 ANALOG/DIGITAL INPUT button (13, 38)
- 4 SOUND button (21, 22, 34, 35, 38)
- 5 TEST button (33, 34, 38)
- 6 BASS BOOST button (21, 38)
- 7 EFFECT button (35, 38)
- 8 SURROUND ON/OFF button (32 – 35, 38)
- 9 SURROUND MODE button (32, 33, 35, 38)
- 10 CHANNEL +/- buttons (40 – 42)
- 11 TV VOL +/- buttons (40, 42)
- 12 TV/VIDEO button (40, 42)
- 13 Operating buttons for audio/video components (39 – 42)
- 14 TV DIRECT button (11, 38)
- 15 Source selecting buttons (10, 11, 13, 23, 25, 38 – 42)  
DVD, STB, VCR, TV, TAPE, FM, AM
- 16
  - 10 keys for selecting preset channels (25, 39, 41, 42)
  - 10 keys for adjusting sound (21, 22, 34, 35, 39)
  - 10 keys for operating audio/video components (41, 42)
- 17 RDS/DVD MENU selector (26 – 29, 39 – 41)
- 18 Operating buttons for RDS and DVD menu (26 – 29, 39 – 41)
- 19 VOLUME +/- buttons (10, 38)
- 20 DIMMER button (12, 38)
- 21 MUTING button (12, 38)

## Before Installation

### General Precautions

- DO NOT insert any metal object into the unit.
- DO NOT disassemble the unit or remove screws, covers, or cabinet.
- DO NOT expose the unit to rain or moisture.

### Locations

- Install the unit in a location that is level and protected from moisture.
- The temperature around the unit must be between  $-5^{\circ}\text{C}$  and  $35^{\circ}\text{C}$  ( $23^{\circ}\text{F}$  and  $95^{\circ}\text{F}$ ).
- Make sure there is good ventilation around the unit. Poor ventilation could cause overheating and damage the unit.

### Handling the unit

- DO NOT touch the power cord with wet hands.
- DO NOT pull on the power cord to unplug the cord. When unplugging the cord, always grasp the plug so as not to damage the cord.
- Keep the power cord away from the connecting cords and the antenna. The power cord may cause noise or screen interference. It is recommended to use a coaxial cable for antenna connection, since it is well-shielded against interference.
- When a power failure occurs, or when you unplug the power cord, the preset settings such as preset FM/AM (MW/LW) channels and sound adjustments may be erased in a few days.

## Checking the Supplied Accessories

Check to be sure you have all of the following supplied accessories. The number in the parentheses indicates the quantity of the pieces supplied.

- Remote Control (1)
- Batteries (2)
- AM (MW/LW) Loop Antenna (1)
- FM Antenna (1)
- SCART Cable (1)
- Digital Coaxial Cord (1)

If anything is missing, contact your dealer immediately.

## Putting Batteries in the Remote Control

Before using the remote control, put two supplied batteries first.

- When using the remote control, aim the remote control directly at the remote sensor on the unit.

### 1 On the back of the remote control, remove the battery cover.

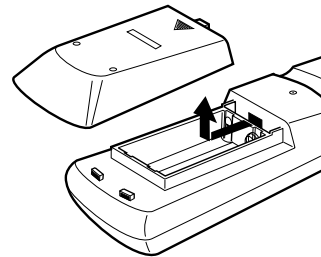

### 2 Insert batteries. Make sure to match the polarity: (+) to (+) and (-) to (-).

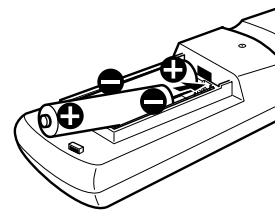

### 3 Replace the cover.

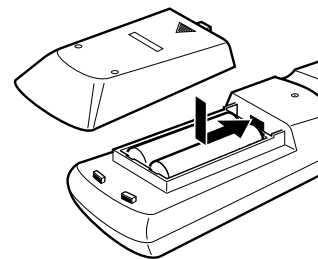

If the range or effectiveness of the remote control decreases, replace the batteries. Use two R6P(SUM-3)/AA(15F) type dry-cell batteries.

### CAUTION:

Follow these precautions to avoid leaking or cracking cells:

- Place batteries in the remote control so they match the polarity: (+) to (+) and (-) to (-).
- Use the correct type of batteries. Batteries that look similar may differ in voltage.
- Always replace both batteries at the same time.
- Do not expose batteries to heat or flame.

# Getting Started

## Connecting the FM and AM (MW/LW) Antennas

If AM (MW/LW) reception is poor, connect an outdoor single vinyl-covered wire (not supplied).

AM (MW/LW) Loop Antenna (supplied)

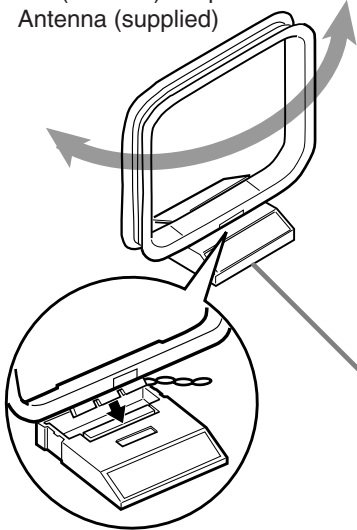

Snap the tabs on the loop into the slots of the base to assemble the AM (MW/LW) loop antenna.

If FM reception is poor, connect outdoor FM antenna (not supplied).

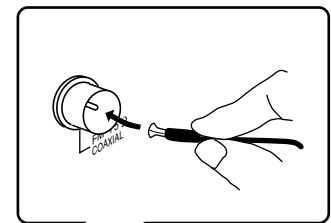

FM Antenna (supplied)

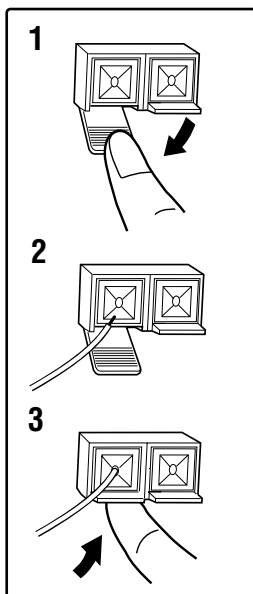
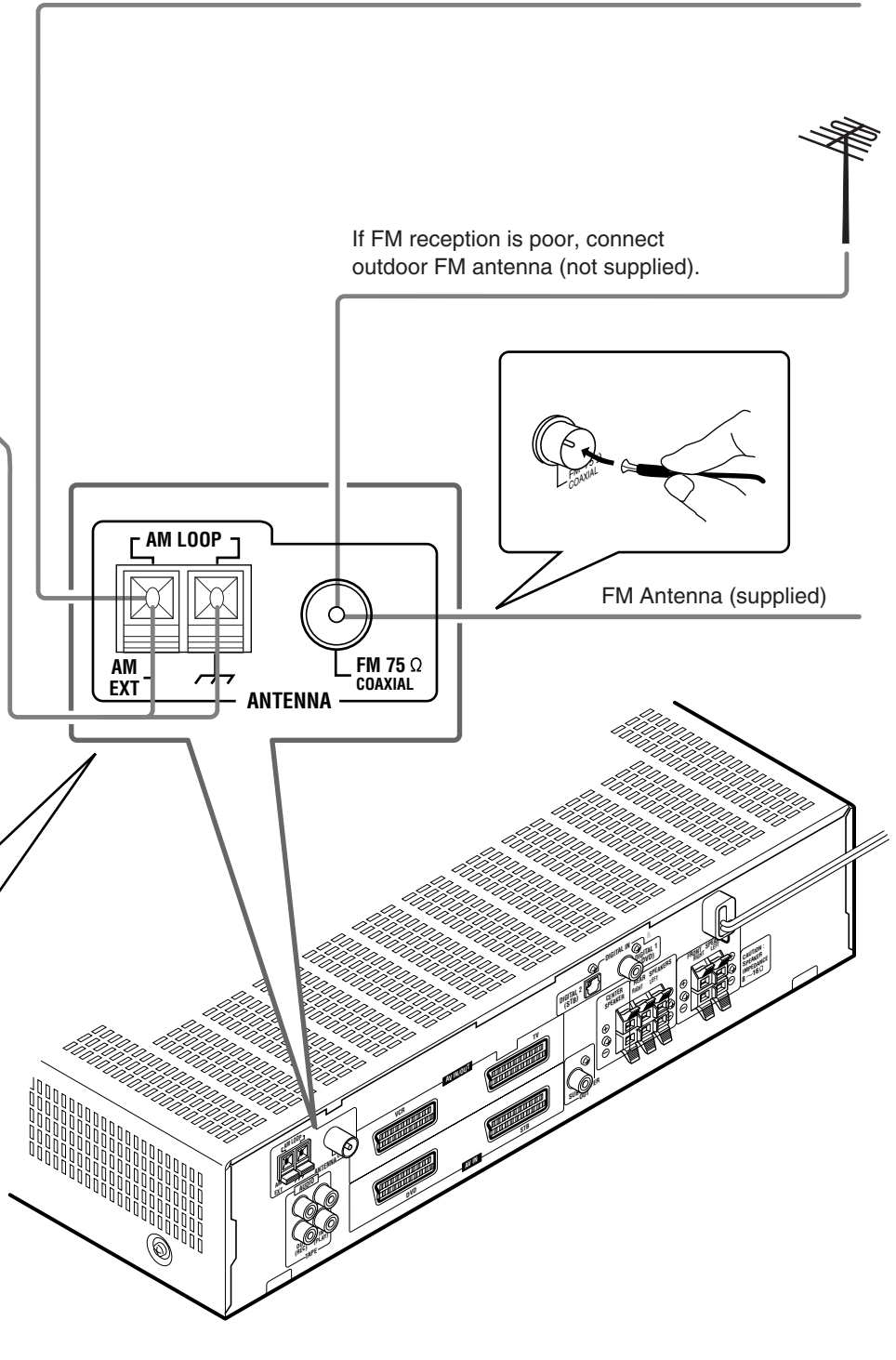



**AM (MW/LW) antenna connection**

Connect the AM (MW/LW) loop antenna supplied to the AM LOOP terminals.

Turn the loop until you have the best reception.

- If the reception is poor, connect an outdoor single vinyl-covered wire to the AM EXT terminal. Keep the AM (MW/LW) loop antenna connected.

**FM antenna connection**

Connect the FM antenna supplied to the FM 75  $\Omega$  COAXIAL terminal as temporary measure.

Extend the supplied FM antenna horizontally.

- If the reception is poor, connect an outdoor FM antenna (not supplied). Before attaching a 75  $\Omega$  coaxial cable (with a standard type connector), disconnect the supplied FM antenna.

**Notes:**

- If the AM (MW/LW) loop antenna wire is covered with vinyl, remove the vinyl while twisting it as shown on the right.
- Make sure the antenna conductors do not touch any other terminals, connecting cords and power cord. This could cause poor reception.

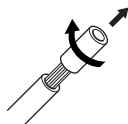
**Connecting the Speakers**

After connecting the front, center and rear speakers, and/or a subwoofer, set the speaker setting information properly to obtain the best possible Surround effect. For details, see page 15.

**CAUTION:**

Use speakers with the SPEAKER IMPEDANCE indicated by the speaker terminals.

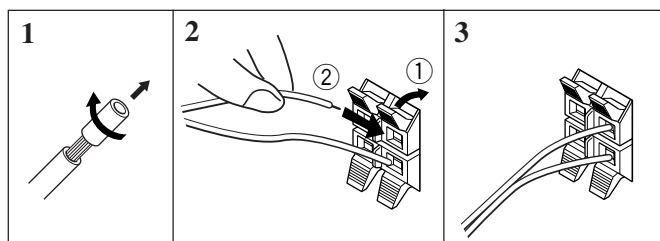
**Connecting the front, center, and rear speakers**

For each speaker, connect the (+) and (-) terminals on the rear panel to the (+) and (-) terminals marked on the speakers respectively.

- 1 Cut, twist and remove the insulation at the end of each speaker cord (not supplied).**
- 2 Press and hold the clamp of the speaker terminal (①), then insert the speaker cord (②).**
- 3 Release the finger from the clamp.**

**Connecting the subwoofer speaker**

By connecting a subwoofer, you can enhance the bass or reproduce the original LFE signals recorded in the digital software.

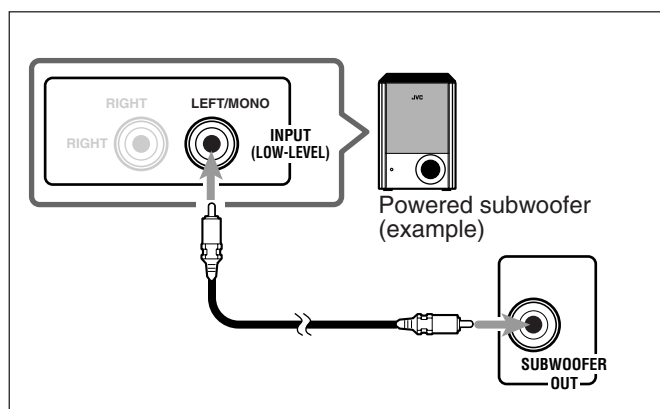

Connect the input jack of a powered subwoofer to the SUBWOOFER OUT jack on the rear panel, using a cable with RCA pin plugs (not supplied).

- Refer also to the manual supplied with your subwoofer.

**Note:**

You can place a subwoofer wherever you like since bass sound is non-directional. Normally place it in front of you.

# Getting Started

## Speaker Layout Diagram

“YES” for the subwoofer and “SML” for the front, center and rear speakers are initial settings. To get best possible sound, change the subwoofer and speaker settings to fit your listening conditions. (See page 15.)

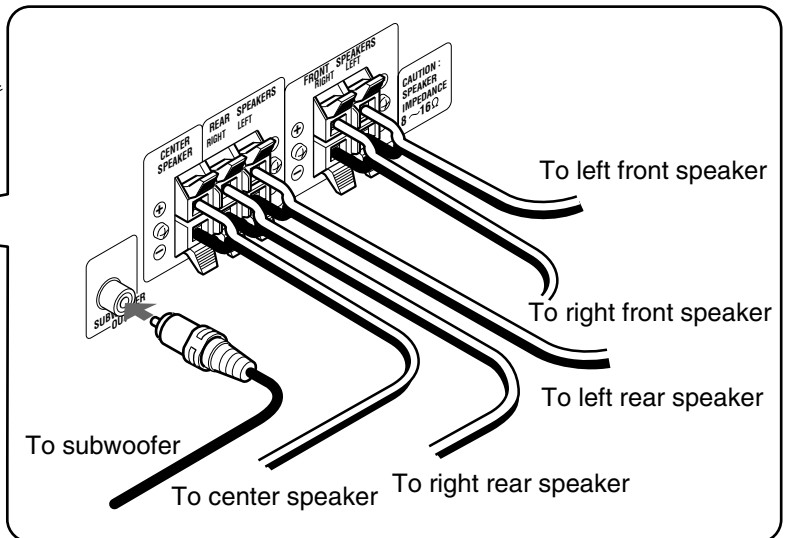
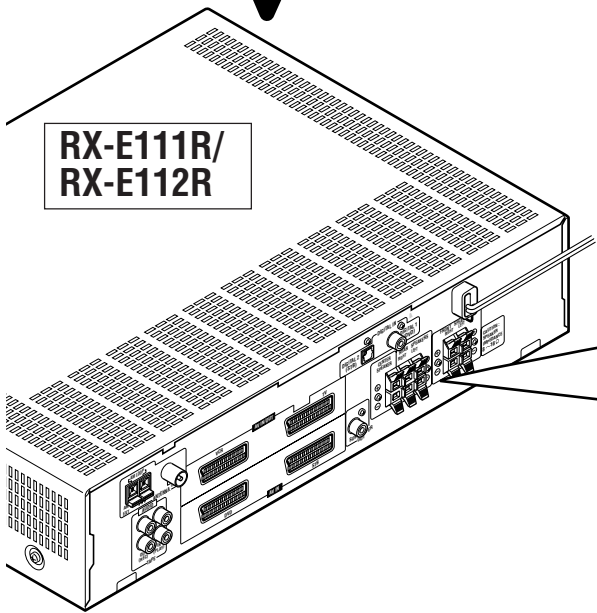
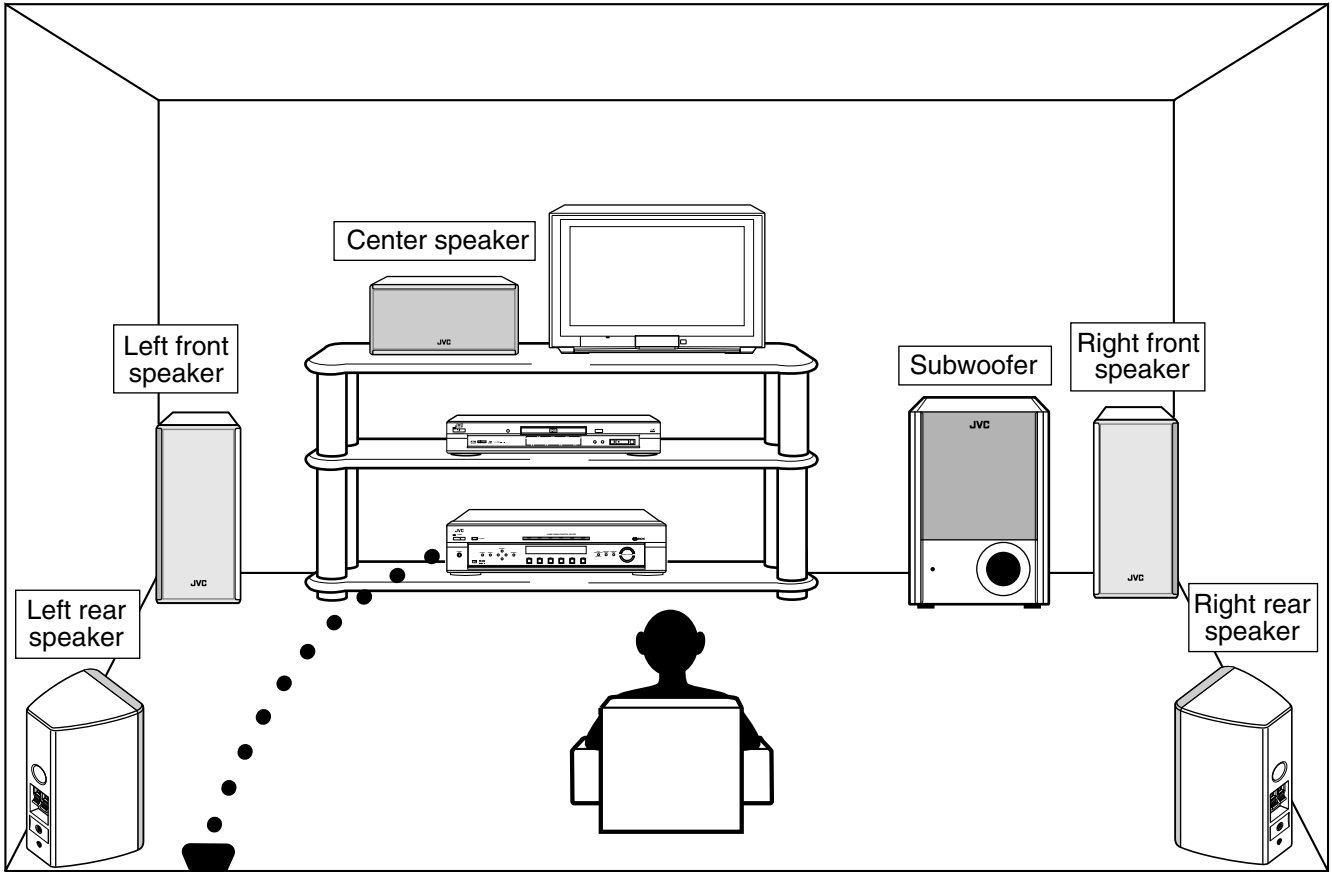

## Connecting Audio/Video Components

Turn off all components before connections.

Audio cords and optical digital cords are not supplied with this unit. Use the cords supplied for the other components or purchase them at an audio or electric appliance store.

**A** Digital coaxial cord (supplied 1 cable)

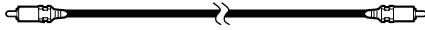

**B** Digital optical cord (not supplied)



**C** Audio cord (not supplied)

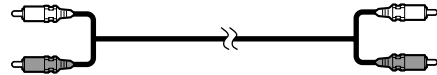

**D** SCART cable (supplied 1 cable)



### Digital connections

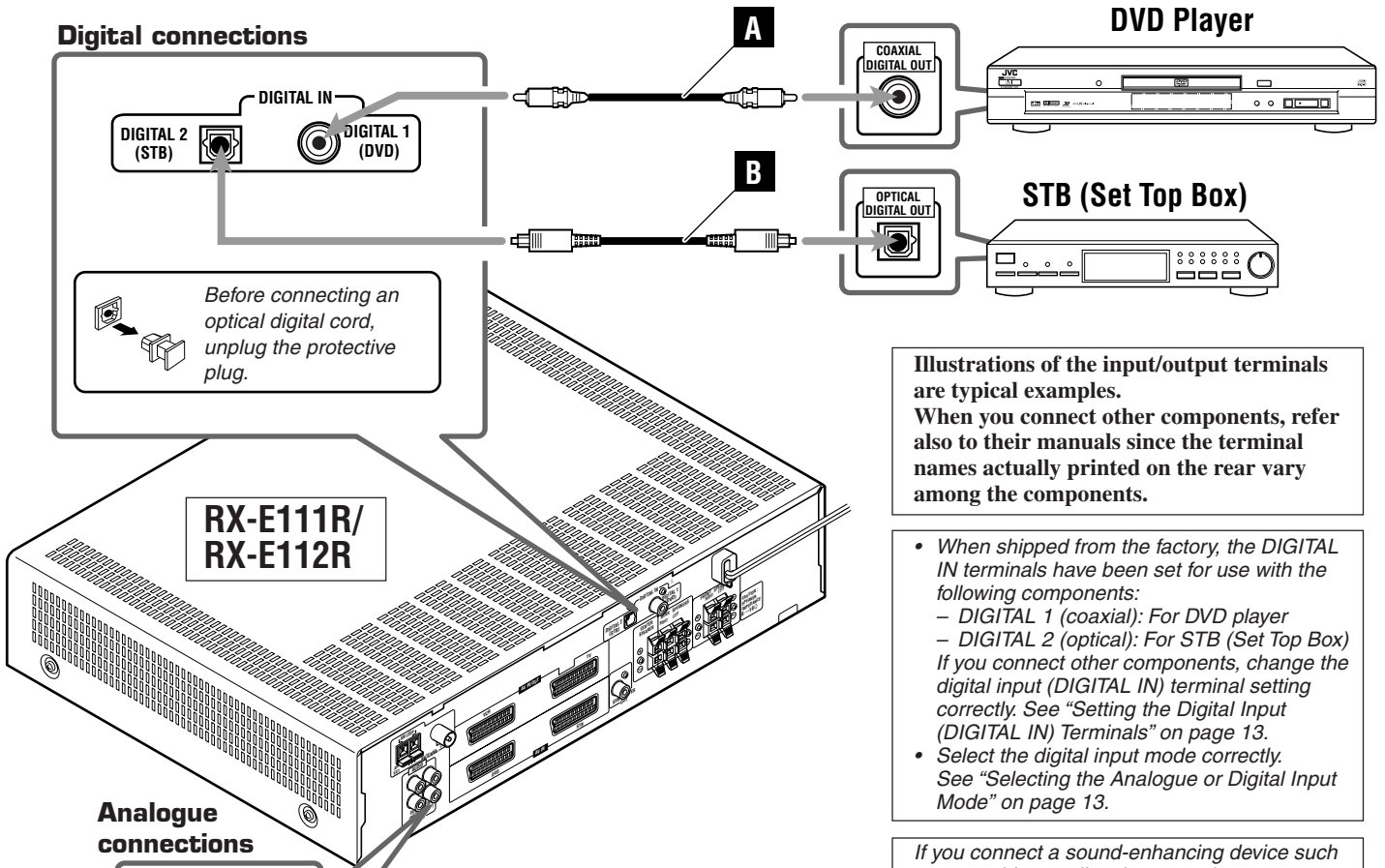

Illustrations of the input/output terminals are typical examples. When you connect other components, refer also to their manuals since the terminal names actually printed on the rear vary among the components.

- When shipped from the factory, the DIGITAL IN terminals have been set for use with the following components:
  - DIGITAL 1 (coaxial): For DVD player
  - DIGITAL 2 (optical): For STB (Set Top Box)
 If you connect other components, change the digital input (DIGITAL IN) terminal setting correctly. See "Setting the Digital Input (DIGITAL IN) Terminals" on page 13.
- Select the digital input mode correctly. See "Selecting the Analogue or Digital Input Mode" on page 13.

If you connect a sound-enhancing device such as a graphic equalizer between the source components and this unit, the sound output through this unit may be distorted.

### Analogue connections

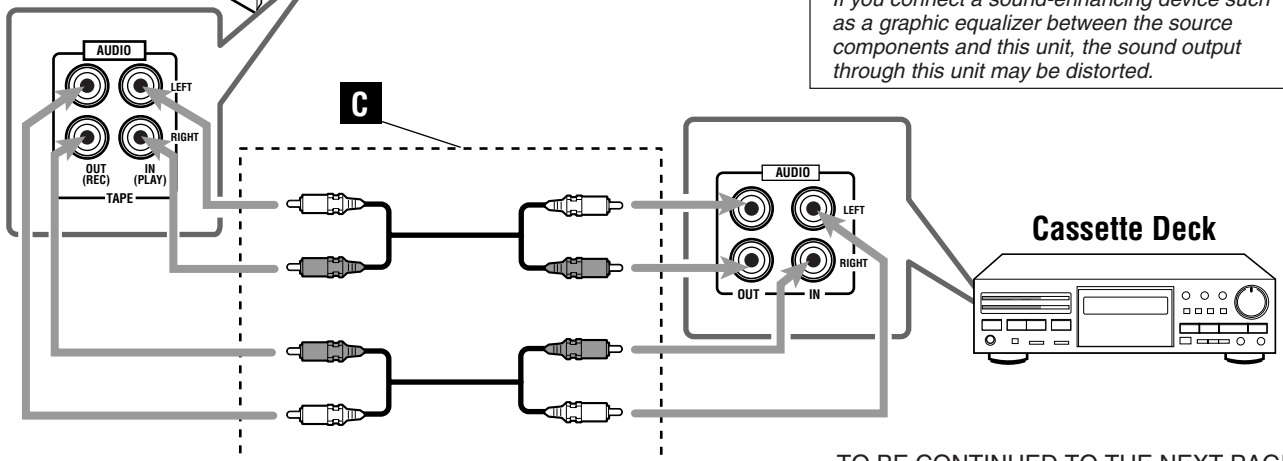

TO BE CONTINUED TO THE NEXT PAGE

# Getting Started

Turn off all components before connections.

Illustrations of the input/output terminals below are typical examples. When you connect other components, refer also to their manuals since the terminal names actually printed on the rear vary among the components.

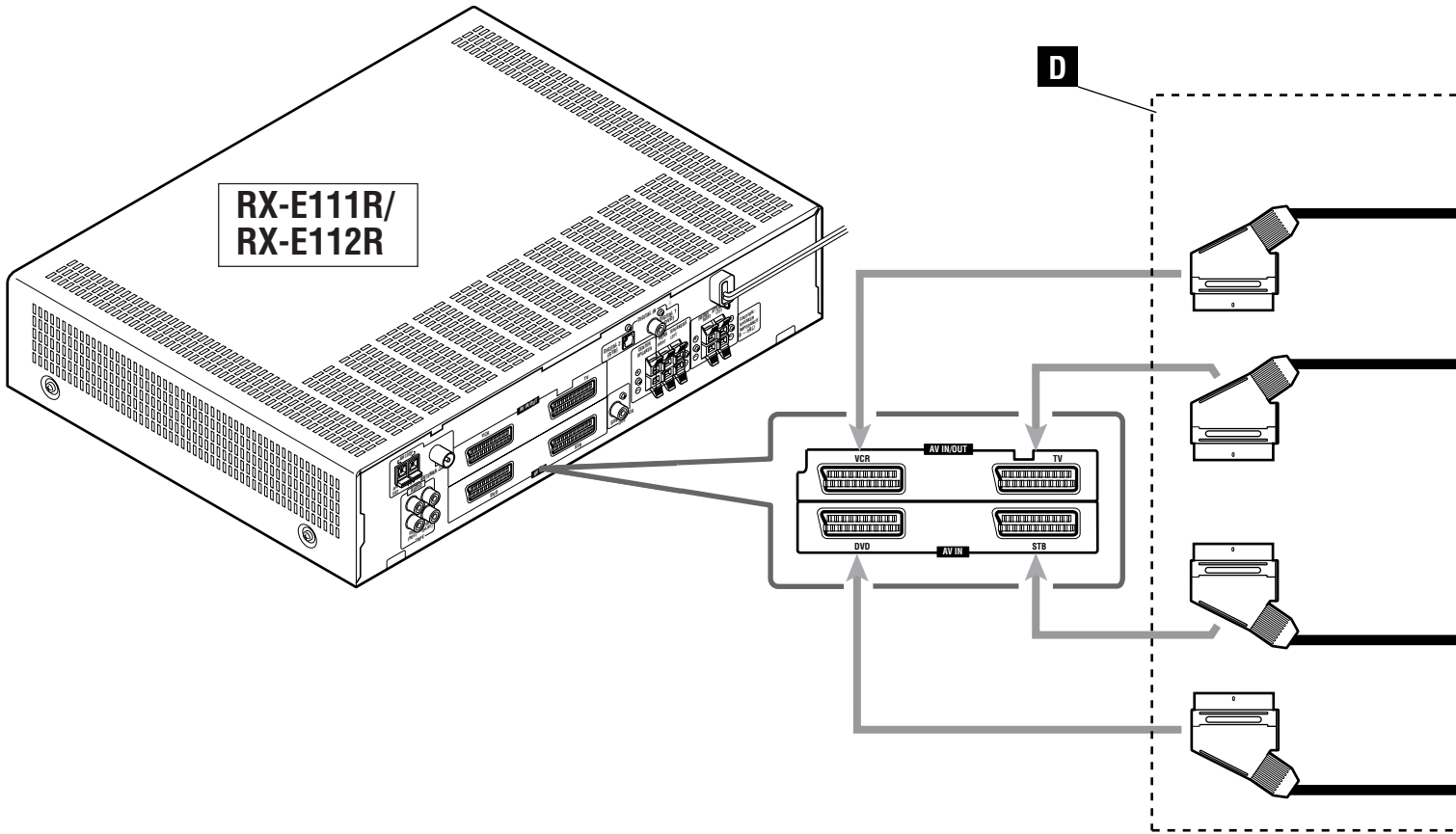

## SCART Terminal Specifications

			TV	VCR	STB	DVD
IN	AUDIO	L/R	○	○	○	○
	VIDEO	Composite	○	○	○	○
		S-video	—	○	○	○
		RGB	—	○	○	○
OUT	AUDIO	L/R	○* <sub>1</sub>	○* <sub>1</sub>	/	
	VIDEO	Composite	○* <sub>1*2</sub>	○* <sub>1*2</sub>		
		S-video	○* <sub>2</sub>	—		
		RGB	○* <sub>2</sub>	—		
T-V LINK			○* <sub>3</sub>	○* <sub>3</sub>	○* <sub>3</sub>	○* <sub>3</sub>

- \*1 The signals input from a SCART terminal cannot be output through the same SCART terminal.
- \*2 The video format of the output video signals are consistent with that of the input video signals. For example, if S-video signals are input to this unit, no signals other than S-video signals can be output from this unit. Refer to the manuals supplied with the video components to check the setting of the input/output video signals.
- \*3 The signals for T-V LINK function are always going through the unit.

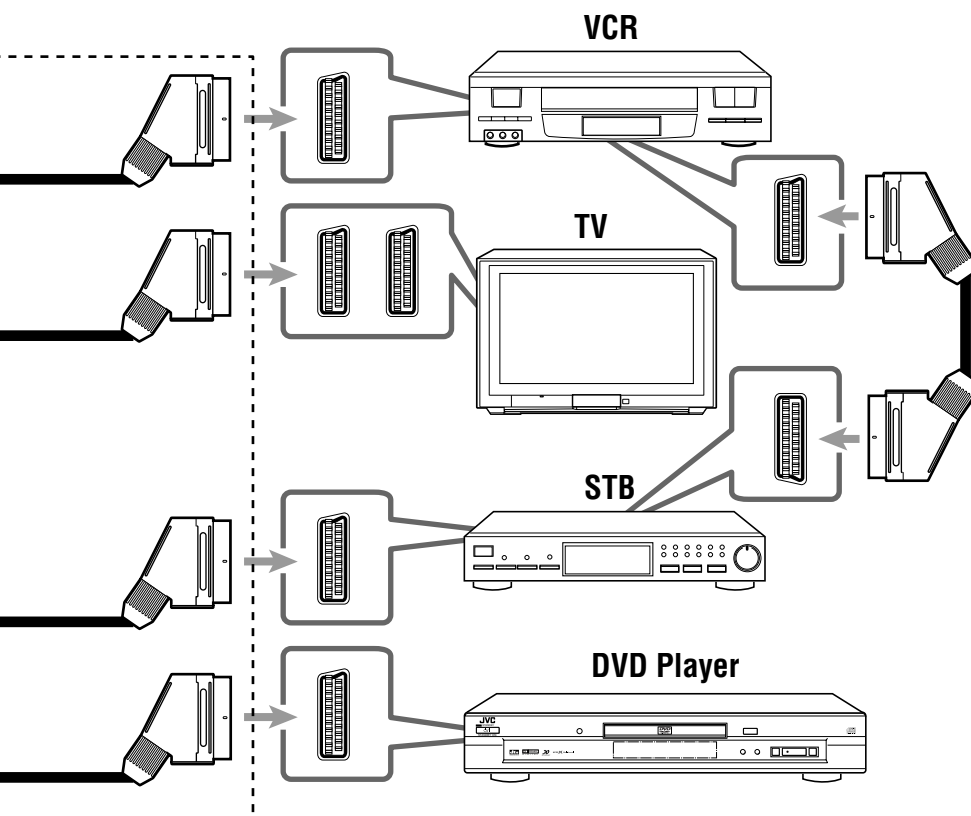

#### For an analogue decoder

To watch or record a scrambled program on your VCR, connect the analogue decoder to your VCR and select the scrambled channel on your VCR.

If there is not an appropriate terminal for the decoder on your VCR, connect the decoder to your TV.

Refer also to the manuals supplied with these equipments.

#### For recording pictures from STB

When you connect a STB and a VCR directly with a SCART cable, you can enjoy recording the pictures from the STB onto VCR without using menu screens of STB. For details, refer also to the manuals supplied with the STB.

#### For digital sounds

- To enjoy the DVD software encoded with Dolby Digital or DTS Digital Surround, connect the DVD player using one of the DIGITAL IN terminals (see page 7).
- To enjoy the digital sounds, use both the SCART cable connection and the digital connection (see page 7).

#### For TV and video format

When the TV is equipped with the plural SCART terminals, refer to the manual supplied with the TV to check the available video signals for each terminal, then connect SCART cable correctly.

This unit cannot convert the video signals (S-video or Composite). When the video signal of one video component is different from that of the other (for example, one is S-video, the other is Composite), you may not see the pictures appropriately. In this case, unify the video signals of all the video components into S-video or Composite, or you need to switch the video signal of TV each time you change the source.

#### For T-V LINK

- You can use T-V LINK function if you connect the T-V LINK compatible TV and VCR to this unit with a fully wired SCART cables. For details on T-V LINK, refer also to the manuals supplied with the TV and the VCR.
- Connect SCART cable to EXT-2 terminal on your JVC's T-V LINK compatible TV for T-V LINK function.
- Some TV, VCR, STB and DVD player support this type of data communication. For complete details, refer also to the manuals supplied with these equipments.

## Connecting the Power Cord

Before plugging the power cord into an AC outlet, make sure that all connections have been made.

#### Plug the power cord into an AC outlet.

Keep the power cord away from the connecting cables and the antenna. The power cord may cause noise or screen interference. We recommend that you use a coaxial cable to connect the antenna, since it is well-shielded against interference.

#### Note:

The preset settings such as preset channels and sound adjustment may be erased in a few days in the following cases:

- When you unplug the power cord.
- When a power failure occurs.

#### CAUTIONS:

- Do not touch the power cord with wet hands.
- Do not pull on the power cord to unplug the cord. When unplugging the cord, always grasp the plug so as not to damage the cord.

# Basic Operations

This manual mainly explains operations using the buttons and controls on the front panel. You can also use the buttons on the remote control if they have the similar names (or marks) as those on the front panel.

If operations using the remote control are different from those using the front panel, they are then explained.

- You can also see “Mastering Remote Operations” on page 38.

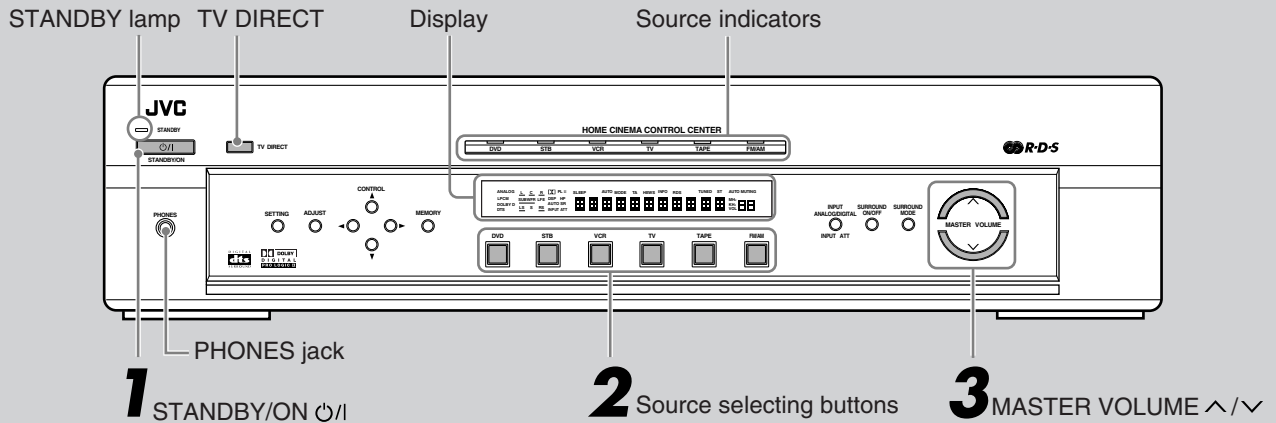

## 1 Turn On the Power

Press STANDBY/ON (or AUDIO on the remote control).

The STANDBY lamp goes off. The current source indicator lights green. The name of the current source (or station frequency) appears on the display.

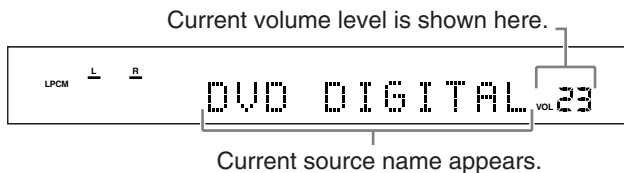
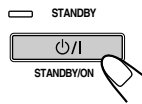

### To turn off the power (into standby)

Press STANDBY/ON again (or AUDIO on the remote control). The STANDBY lamp lights up.

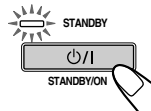

#### Note:

A small amount of power is consumed in standby mode. To turn the power off completely, unplug the AC power cord.

## 2 Select the Source to Play

Press one of the source selecting buttons.



- DVD : Select the DVD player.
- STB : Select the STB.
- VCR : Select the VCR.
- TV : Select the TV tuner.
- TAPE : Select the cassette recorder.
- FM/AM : Select an FM or AM (MW/LW) broadcast.

The selected source indicator lights green.

#### Note:

When you have connected some digital source components using the digital terminals (see page 7), see “Basic Settings” on pages 13 and 14 to finish the digital input terminal setting and digital input mode setting correctly before use.

## 3 Adjust the Volume

To increase the volume, press and hold MASTER VOLUME (or VOLUME + on the remote control).

To decrease the volume, press and hold MASTER VOLUME (or VOLUME – on the remote control).

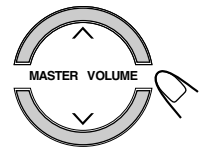

#### CAUTION:

Always set the volume to the minimum before starting any sources. If the volume is set at its high level, the sudden blast of sound energy can permanently damage your hearing and/or ruin your speakers.

#### Notes:

- The volume level can be adjusted within the range of “0” (minimum) to “70” (maximum).
- Each time you press the button, the volume level changes by 2 steps from “0” (minimum) to “14,” and by 1 step from “14” to “70” (maximum).

### Listening with headphones

Connect a pair of headphones to the PHONES jack on the front panel. This cancels the Surround mode currently selected, deactivates speakers, and activates the HEADPHONE mode. The HP indicator lights up on the display.

- Disconnecting a pair of headphone from the PHONES jack cancels the HEADPHONE mode and activates speakers.

#### HEADPHONE mode

When using the headphones, following signals are output regardless of your speaker setting:

- For 2 channel sources, the front left and right channel signals are output directly from the left and right headphones.
  - For multichannel sources, the front left and right, center and rear channel signals are down-mixed and then output from the headphones without missing bass element.
- You can enjoy multichannel sound source using the headphones.



**CAUTION:**

Be sure to turn down the volume:

- Before connecting or putting on headphones, as high volume can damage both the headphones and your hearing.
- Before removing headphones, as high volume may output from the speakers.

## Activating TV Direct

TV Direct enables you to use this unit as an AV selector while the unit is not turned on.

When TV Direct is activated, the pictures and sounds go from the video components such as DVD player to the TV through this unit. In this case, you can use the video components and the TV as if they were connected directly.

- This function takes effect only when the video components and TV are connected to this unit with SCART cables.
- This function takes effect for the following sources—DVD, STB, and VCR.
- This unit can be automatically turned on or off, and/or select the source automatically when you set the Auto Function mode to “AUTO1” or “AUTO2.” For details, see “Setting the Auto Function Mode” on page 19.

To activate (or deactivate) TV Direct, follow the procedure below:

### 1 Press TV DIRECT.

All the indications disappear, then the source indicator currently selected lights red.



### 2 Turn on the video component and TV.

### 3 Press one of the source selecting buttons—DVD, STB, or VCR.

The indicator corresponding to the selected source lights red.

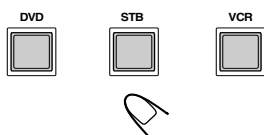

To cancel TV Direct and turn off the unit, press STANDBY/ON (or AUDIO on the remote control). The unit is turned off and the STANDBY lamp lights up.

To cancel TV Direct and turn on the unit, press TV DIRECT on the unit (or AUDIO on the remote control). The unit is turned on and the source indicator currently selected lights green.

#### Notes:

- When TV Direct is activated, you cannot enjoy any of the sound effects this unit produces, and cannot use the speakers connected to this unit.
- You can use T-V LINK function between TV and VCR while the TV Direct is activated.

### Basic adjustment of auto memory

This unit memorizes sound settings for each source:

- when you turn off the power,
- when you change the source, and
- when you change the analogue/digital input mode (see page 13).

When you change the source, the memorized settings for the newly selected source are automatically recalled.

The followings can be stored for each source:

- Analogue/digital input mode (see page 13)
- Input attenuator mode (see page 20)
- Balance (see page 20)
- Bass boost (see page 21)
- Tone adjustment (see page 21)
- Subwoofer output level (see page 22)
- Surround mode selection (see pages 33 – 37)

#### Note:

If the source is FM or AM, you can assign a different setting for each band.

### For recording

You can record sounds of any sources playing through the unit to the VCR or the cassette deck.

While recording, you can listen to the selected sound source at whatever sound level you like without affecting the sound levels of the recording.

#### Note:

Sound adjustments (see page 20) and Surround adjustments (see pages 32 to 37) cannot affect the recording.

### Signal and speaker indicators on the display

Signal indicators

Speaker indicators

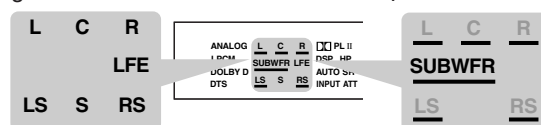

#### The following signal indicators light up —:

- L : • **When digital input is selected:** Lights up when the left channel signal comes in.  
 • **When analog input is selected:** Always lights up.
- R : • **When digital input is selected:** Lights up when the right channel signal comes in.  
 • **When analog input is selected:** Always lights up.
- C : Lights up when the center channel signal comes in.
- LS : Lights up when the left rear channel signal comes in.
- RS : Lights up when the right rear channel signal comes in.
- S : Lights up when the monaural rear channel signal or Dolby Surround encoded signal comes in.
- LFE: Lights up when the LFE channel signal comes in.

#### The speaker indicators light up as follows:

- The subwoofer speaker indicator ( **SUBWFR** ) lights up when “SUBWFR” is set to “YES” (see page 15).
- The other speaker indicators light up only when the corresponding speaker is activated, and also when required for the current playback.

# Basic Operations

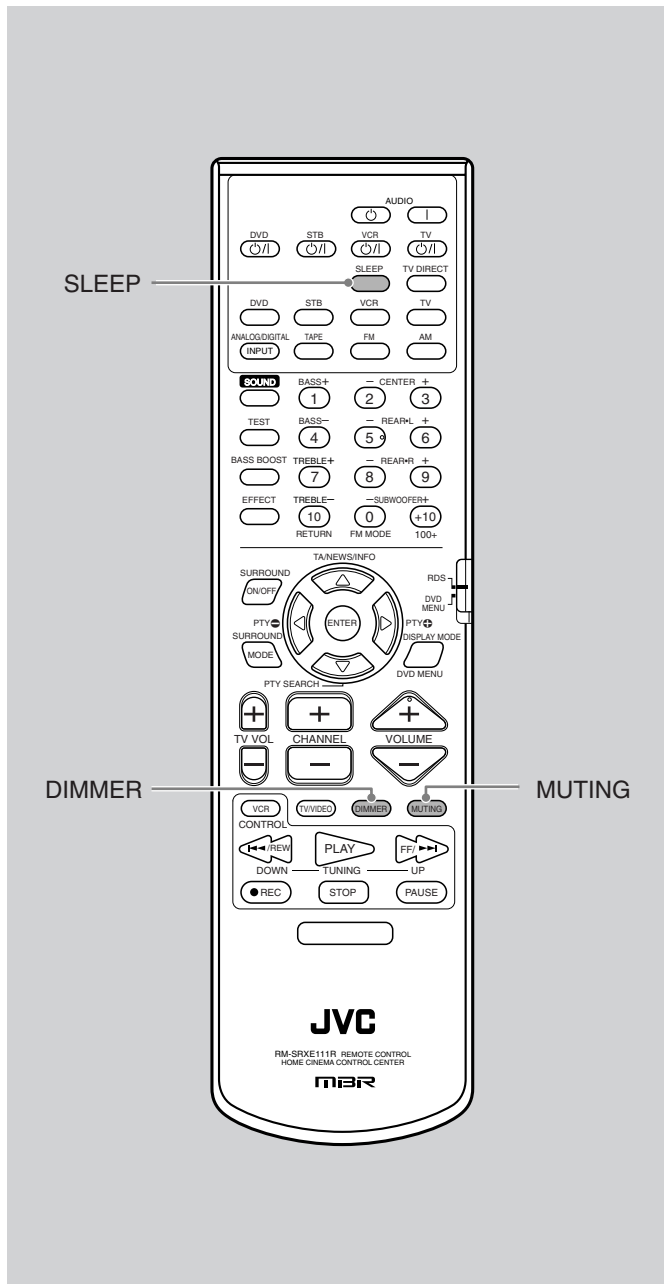

## Turning Off the Power with the Sleep Timer Remote ONLY

You can fall asleep while listening to music—Sleep Timer.

Press **SLEEP on the remote control** repeatedly. The SLEEP indicator lights up on the display, and the shut-off time changes in 10 minutes intervals.

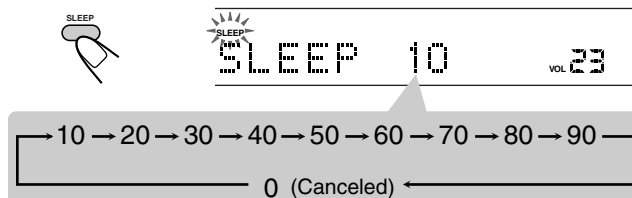

**When the shut-off time comes:**  
The unit turns off automatically.

**To check or change the remaining time until the shut-off time:**  
Press SLEEP once.  
The remaining time (in minutes) until the shut-off time appears.

- To change the shut-off time, press SLEEP repeatedly.

**To cancel the Sleep Timer:**  
Press SLEEP repeatedly until “SLEEP 0” appears on the display. (The SLEEP indicator goes off.)

- Turning off the power also cancels the Sleep Timer.

## Changing the Display Brightness Remote ONLY

You can dim the display.

Press **DIMMER on the remote control**.

- Each time you press the button, the display dims and brightens alternately.



## Turning Off the Sounds Temporarily—Muting Remote ONLY

Press **MUTING on the remote control** to mute the sound through all speakers connected. “MUTING” appears on the display and the volume turns off (the volume level indicator goes off).

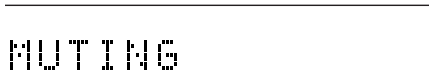

**To restore the sound,** press MUTING again.

- Pressing VOLUME +/- (or MASTER VOLUME ^/∨ on the front panel) also restores the sound.



# Basic Settings

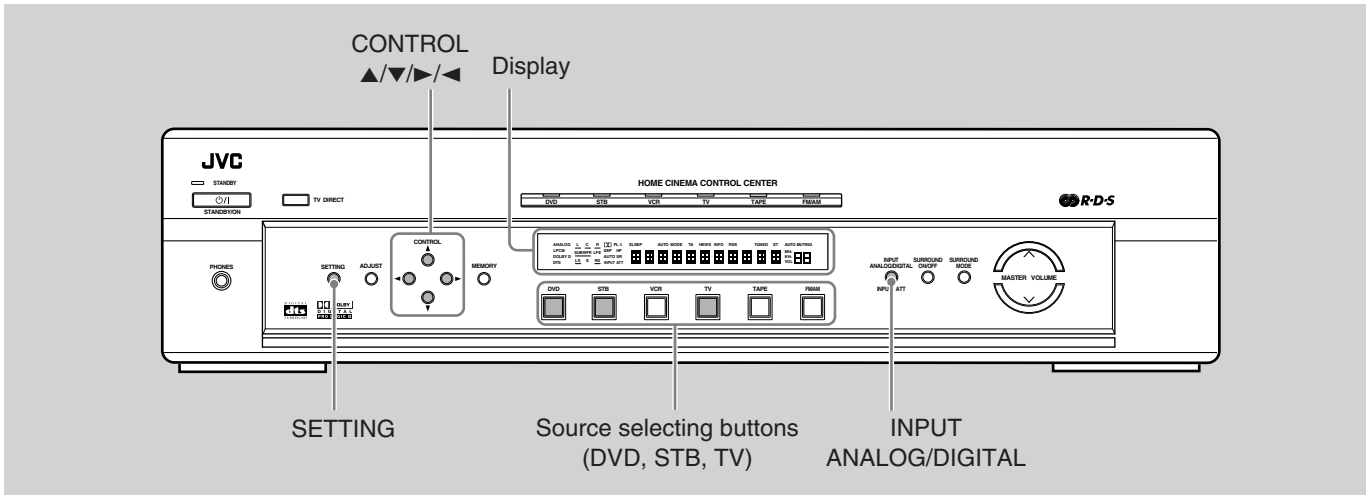

## Setting the Digital Input (DIGITAL IN) Terminals



When you use the digital input terminals, register what components are connected to which terminals (DIGITAL IN 1/2) so that the correct source name will appear when you select the digital source.

Before you start, remember...

There is a time limit in doing the following steps. If the setting is canceled before you finish, start from step 1 again.

### 1 Press SETTING.



The CONTROL buttons now work for basic settings.

### 2 Press CONTROL ▼ (or ▲) repeatedly until "DGT (Digital)" (with the current setting)\* appears on the display.



DGT 1DVD2STB VOL 23

\* "1DVD2STB" is the initial setting. If you have already changed setting, another combination will be shown.

### 3 Press CONTROL ► (or ◀) to select the appropriate digital terminal setting.

Each time you press the button, the display changes to show the following:

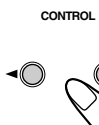

DGT 1DVD2STB VOL 23

DGT1DVD2STB	↔	DGT1DVD 2TV	↔
DGT1STB2DVD	↔	DGT1STB 2TV	↔
DGT1TV 2DVD	↔	DGT1TV 2STB	↔

(back to the beginning)

### Note:

When shipped from the factory, the DIGITAL IN terminals have been set for use with the following components:

- DIGITAL 1 (coaxial): For DVD player
- DIGITAL 2 (optical): For STB (Set Top Box)

## Selecting the Analogue or Digital Input Mode

When you have connected digital source components using both the analogue connection and the digital connection methods (see page 7), you need to select the input mode correctly.

### 1 Press one of the source selecting buttons (DVD, STB, or TV)\* for which you want to change the input mode.

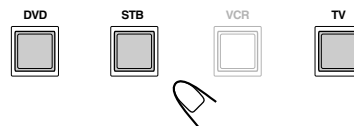

### Note:

\* Among the sources listed above, you can select the digital input only for the sources which you have selected the digital input terminals for. (See "Setting the Digital Input (DIGITAL IN) Terminals".)

### 2 Press INPUT ANALOG/DIGITAL (INPUT ATT)—or ANALOG/DIGITAL INPUT on the remote control—to select the analogue or digital input mode.

- Each time you press the button, the input mode alternates between the analogue input ("ANALOGUE"\*) and the digital input ("DGT AUTO").



ANALOG L R SUBWFR ANALOGUE

DGTL AUTO ↔ ANALOGUE

\* "ANALOGUE" is the initial setting.

TO BE CONTINUED TO THE NEXT PAGE

# Basic Settings

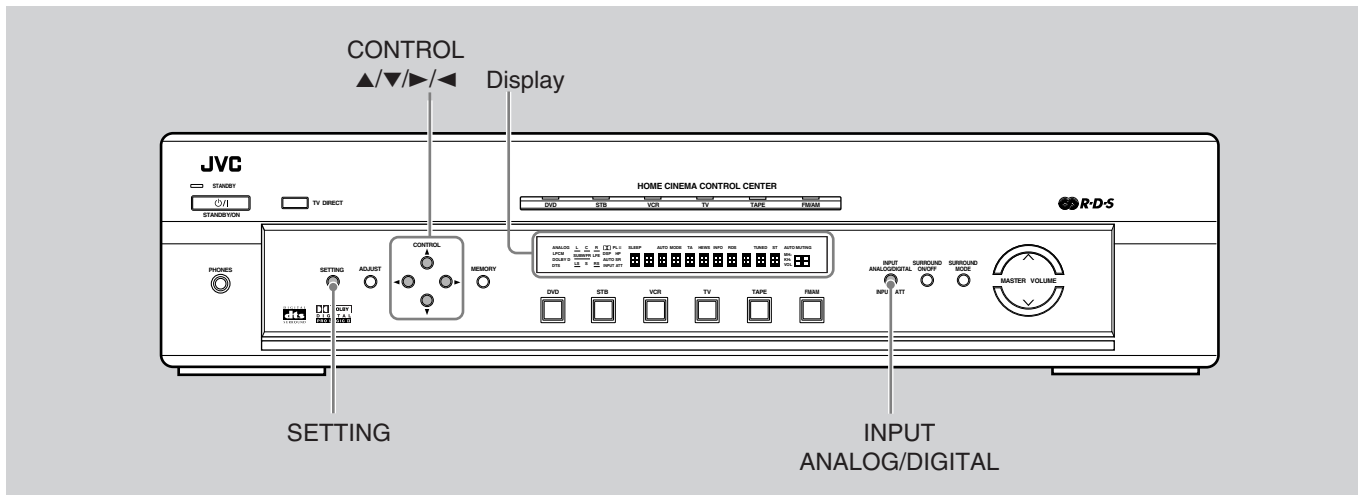

**DGTL AUTO** : Select this for the digital input mode. The unit automatically detects the incoming signal format, then the digital signal indicator for the detected signals lights up.

**ANALOGUE** : Select this for the analogue input mode.

If the following symptoms occur while playing Dolby Digital or DTS Digital Surround software with “DGTL AUTO” selected, follow the procedure below:

- Sound does not come out at the beginning of playback.
- Noise comes out while searching for or skipping chapters or tracks.

**1** Press INPUT ANALOG/DIGITAL (INPUT ATT)—or ANALOG/DIGITAL INPUT on the remote control—to select the digital input mode (“DGTL AUTO”).



**2** Press CONTROL ► (or ◀) to select “DGTL D.D.” or “DGTL DTS” while “DGTL AUTO” still remains on the display.

- Each time you press the button, the digital input mode changes as follows:

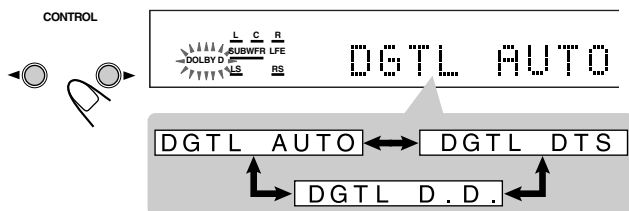

- To play back software encoded with Dolby Digital, select “DGTL D.D.”
- To play back software encoded with DTS Digital Surround, select “DGTL DTS.”

**Note:**

When you turn off the power or select another source, “DGTL DTS” and “DGTL D.D.” are canceled and the digital input mode is automatically reset to “DGTL AUTO.”

The following are the analogue/digital signal indicators on the display to indicate what type of the signal comes into the unit.

<b>ANALOG</b>	: Lights when the analogue input is selected.
<b>LPCM</b>	: Lights when Linear PCM signals come in.
<b>DOLBY D</b>	: • Lights when Dolby Digital signals come in. • Flashes when “DGTL D.D.” is selected for software not encoded with Dolby Digital.
<b>DTS</b>	: • Lights when DTS Digital Surround signals come in. • Flashes when “DGTL DTS” is selected for software not encoded with DTS Digital Surround.

**Note:**

When “DGTL AUTO” cannot recognize the incoming signals, no digital signal indicators light up on the display.

“YES” for the subwoofer and “SML” for the front, center and rear speakers are initial settings. To get best possible sound, change the subwoofer and speaker settings to fit your listening conditions.

## Setting the Subwoofer Information



Register whether you have connected a subwoofer or not. If you have already connected a subwoofer, follow the procedure below.

### Before you start, remember...

There is a time limit in doing the following steps. If the setting is canceled before you finish, start from step 1 again.

### 1 Press SETTING.

The CONTROL buttons now work for basic settings.

### 2 Press CONTROL ▼ (or ▲) repeatedly until “SUBWFR (Subwoofer)” (with the current setting)\* appears on the display.

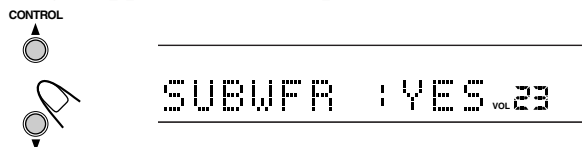

\* “YES” is the initial setting. If you have already changed the setting, “NO” will be shown.

### 3 Press CONTROL ► (or ◀) to select “YES.”

- Each time you press the button, the subwoofer setting alternates between “YES” and “NO.”

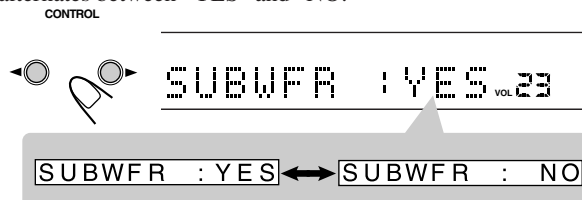

**YES** : Select this when you have connected a subwoofer. The subwoofer speaker indicator ( **SUBWFR** ) lights up on the display (see page 11). You can adjust the subwoofer output level (see page 22).

**NO** : Select this when you have not connected or have disconnected a subwoofer.

## Setting the Speakers Information



To obtain the best possible effect from the Surround modes (see page 32), register the following information after all connections are completed.

- Speaker Size—FRNT SP, CNTR SP, REAR SP
- Speaker Distance—FRNT D, CNTR D, REAR D
- Crossover Frequency—CROSS
- Low Frequency Effect Attenuator—LFE
- Dynamic Range Compression—D.COMP

### Speaker Size—FRNT SP, CNTR SP, REAR SP

Register the sizes of all the connected speakers.

- When you change your speakers, register the information about the speakers again.

### Before you start, remember...

There is a time limit in doing the following steps. If the setting is canceled before you finish, start from step 1 again.

### 1 Press SETTING.

The CONTROL buttons now work for basic settings.

### 2 Press CONTROL ▼ (or ▲) repeatedly until one of the following speakers (with the current setting)\* appears.

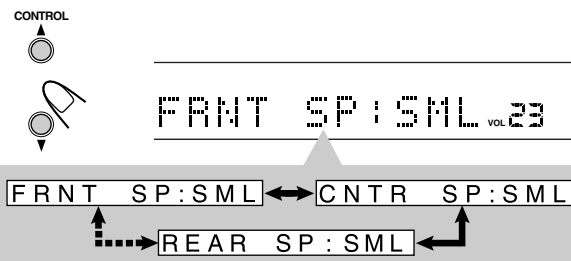

**FRNT SP** (Front Speaker) : To register the front speaker size.

**CNTR SP** (Center Speaker): To register the center speaker size.

**REAR SP** (Rear Speaker) : To register the rear speaker size.

\* “SML (small)” is the initial setting. If you have already changed the setting, another size will be shown.

### 3 Press CONTROL ► (or ◀) to select the appropriate speaker size.

- Each time you press the button, the speaker size changes as follows:

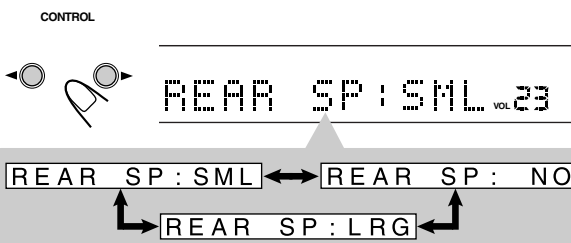

Ex.: When registering the rear speaker size.

**LRG** (Large) : Select this when the speaker size is relatively large. (See “Notes” below.)

**SML** (Small) : Select this when the speaker size is relatively small. (See “Notes” below.)

**NO** : Select this when you have not connected a speaker. (Not selectable for the front speakers.)

### 4 Repeat steps 2 and 3 to select the appropriate size for the other speakers.

#### Notes:

- Use the following criteria as reference when adjusting:
  - If the size of the cone speaker unit built in your speaker is greater than 12 cm, select “LRG (large),” and if it is smaller than 12 cm, select “SML (small).”
- If you have selected “NO” for the subwoofer, you can only select “LRG (large)” for the front speaker size.
- If you have selected “SML (small)” for the front speaker size, you cannot select “LRG (large)” for the center and rear speaker sizes.

# Basic Settings

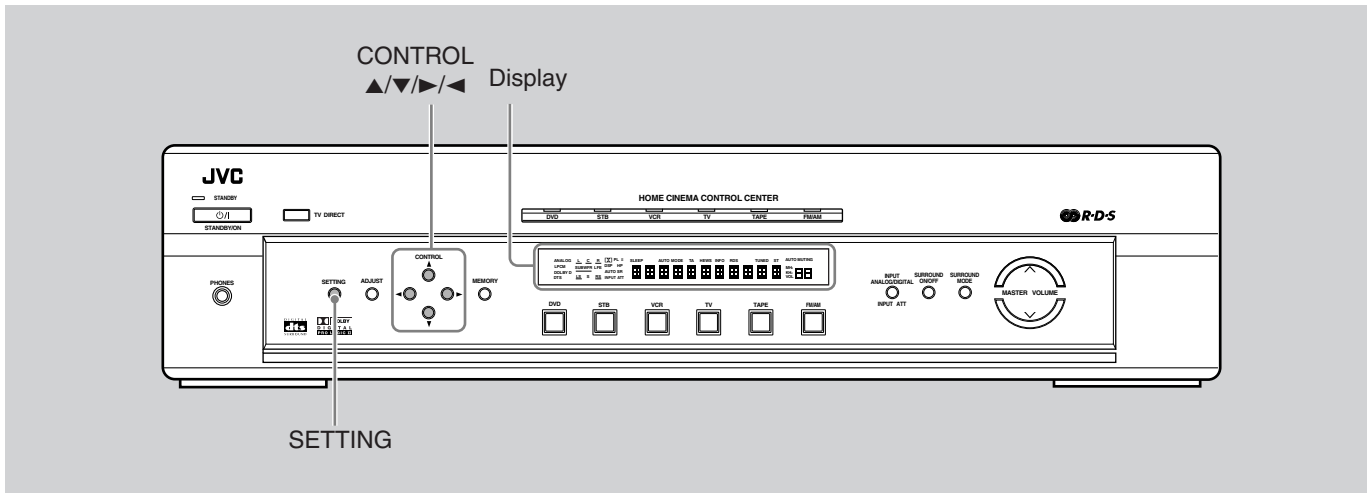

## Speaker Distance—FRNT D, CNTR D, REAR D

The distance from your listening point to the speakers is another important element to obtain the best possible surround sound of the Surround and DSP modes.

You need to set the distance from your listening point to the speakers. By referring to the speaker distance setting, this unit automatically sets the delay time of the sound through each speaker so that sounds through all the speakers can reach you at the same time.

### Before you start, remember...

There is a time limit in doing the following steps. If the setting is canceled before you finish, start from step 1 again.

### 1 Press SETTING.



The CONTROL buttons now work for basic settings.

### 2 Press CONTROL ▼ (or ▲) repeatedly until “FRNT D (Front Distance),” “CNTR D (Center Distance)” or “REAR D (Rear Distance)” (with the current setting)\* appears on the display.

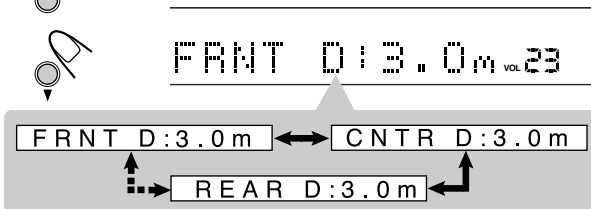

**FRNT D** (Front Distance) : To adjust the front speakers distance from your listening point.

**CNTR D** (Center Distance): To adjust the center speaker distance from your listening point.

**REAR D** (Rear Distance) : To adjust the rear speakers distance from your listening point.

\* “3.0 m” is the initial setting. If you have already changed the setting, another setting will be shown.

### 3 Press CONTROL ► (or ◀) to select the distance.

- Each time you press the button, the distance changes in 0.3 m intervals.

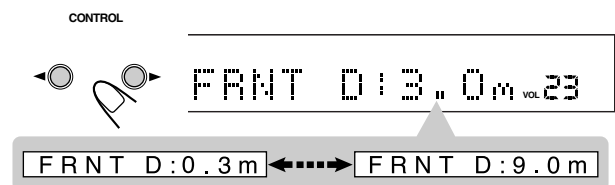

Ex.: When adjusting the front speakers distance.

### 4 Repeat steps 2 and 3 to adjust the distance for the other speakers.

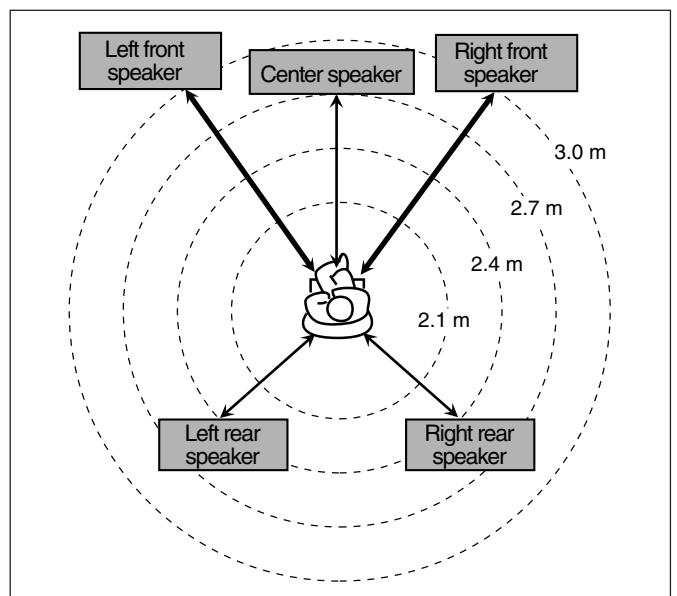

Example: In this case, set “FRNT D” to “3.0m,” set “CNTR D” to “2.7m” and set “REAR D” to “2.4m.”

### Note:

If you have selected “NO” for the center and rear speakers setting, you cannot set the speaker distance for the center and rear speakers.

## Crossover Frequency—CROSS

Small speakers cannot reproduce the bass sounds efficiently. If you use a small speaker in any position, this unit automatically reallocates the bass sound elements assigned to the small speaker to the large speakers.

To use this function properly, set this crossover frequency level according to the size of the small speaker connected.

- If you have selected “LRG (large)” for all speakers, this function will not take effect.

### Before you start, remember...

There is a time limit in doing the following steps. If the setting is canceled before you finish, start from step **1** again.

#### 1 Press SETTING.

 The CONTROL buttons now work for basic settings.

#### 2 Press CONTROL ▼ (or ▲) repeatedly until “CROSS (Crossover)” (with the current setting)\* appears on the display.

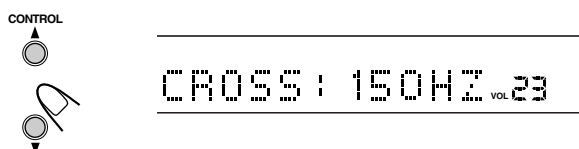

\* “150HZ” is the initial setting. If you have already changed the setting, another frequency will be shown.

#### 3 Press CONTROL ► (or ◀) to select the crossover frequency level you like to use.

- Each time you press the button, the crossover frequency level changes as follows:

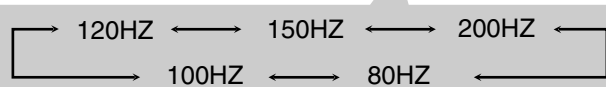
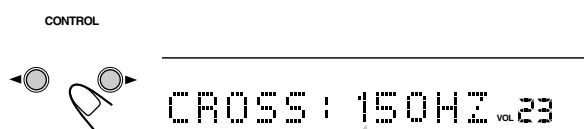

- Use the following criteria as reference when adjusting:

**80HZ** : Select this frequency when the cone speaker unit built in the speaker is about 12 cm.

**100HZ** : Select this frequency when the cone speaker unit built in the speaker is about 10 cm.

**120HZ** : Select this frequency when the cone speaker unit built in the speaker is about 8 cm.

**150HZ** : Select this frequency when the cone speaker unit built in the speaker is about 6 cm.

**200HZ** : Select this frequency when the cone speaker unit built in the speaker is less than 5 cm.

### Note:

Crossover frequency is not valid for the HEADPHONE mode.

## Low Frequency Effect Attenuator—LFE

If the bass sound is distorted while playing back software encoded with **Dolby Digital** or **DTS Digital Surround**, follow the procedure below:

- This function takes effect only when the subwoofer (LFE) signals come in.

### Before you start, remember...

There is a time limit in doing the following steps. If the setting is canceled before you finish, start from step **1** again.

#### 1 Press SETTING.

 The CONTROL buttons now work for basic settings.

#### 2 Press CONTROL ▼ (or ▲) repeatedly until “LFE (Low Frequency Effect)” (with the current setting)\* appears on the display.

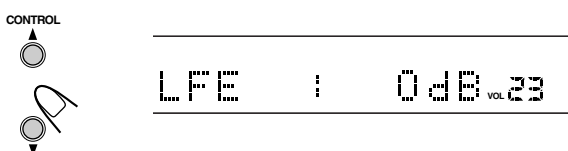

\* “0dB” is the initial setting. If you have already changed the setting, “-10dB” will be shown.

#### 3 Press CONTROL ► (or ◀) to select the LFE attenuator level.

- Each time you press the button, the LFE attenuator level changes as follows:

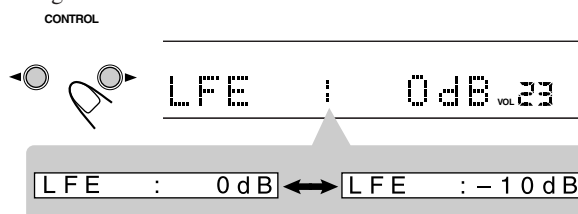

**0dB** : Normally select this.

**-10dB** : Select this when the bass sound is distorted.

## Dynamic Range Compression—D.COMP

You can compress the dynamic range (difference between maximum sound and minimum sound) of the reproduced sound. This is useful when enjoying surround sound at night.

- This function takes effect only when playing back a source encoded with **Dolby Digital**.

### Before you start, remember...

There is a time limit in doing the following steps. If the setting is canceled before you finish, start from step **1** again.

#### 1 Press SETTING.

 The CONTROL buttons now work for basic settings.

TO BE CONTINUED TO THE NEXT PAGE

# Basic Settings

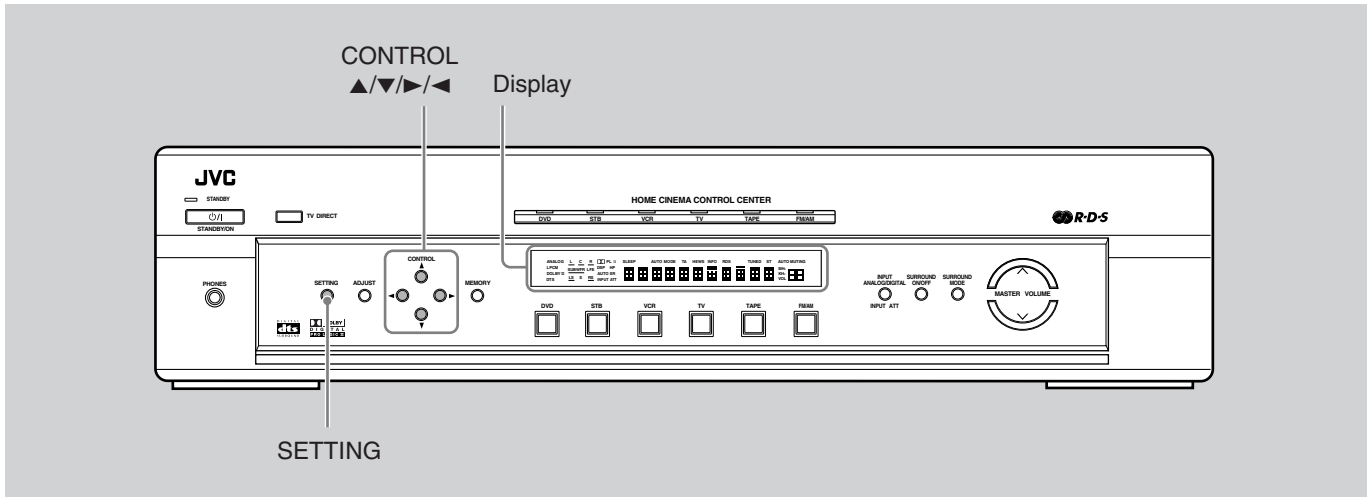

**2** Press CONTROL▼ (or ▲) repeatedly until “D.COMP (Dynamic Range Compression)” (with the current setting)\* appears on the display.



\* “MID” is the initial setting. If you have already changed the setting, another setting will be shown.

**3** Press CONTROL▶ (or ◀) to select the appropriate compression level.

- Each time you press the button, the compression level changes as follows:

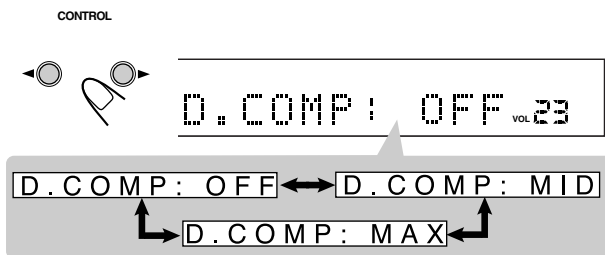

- OFF** : Select this when you want to enjoy surround with its full dynamic range. (No effect applied.)
- MID** : Select this when you want to reduce the dynamic range a little.
- MAX** : Select this when you want to apply the compression effect fully. (Useful at night.)

**Note:**

The result from compressing dynamic range differs for each source.

## Setting Auto Surround



Surround mode is automatically activated when a multichannel signal comes into this unit through the digital terminal. You can enjoy Surround mode simply by selecting the source (with digital input selected for that source)—Auto Surround.

To activate Auto Surround, follow the procedure below.

**Before you start, remember..**

There is a time limit in doing the following steps. If the setting is canceled before you finish, start from step 1 again.

**1** Press SETTING.



The CONTROL buttons now work for basic settings.

**2** Press CONTROL▼ (or ▲) repeatedly until “AUTO SR (Auto Surround)” (with the current setting)\* appears on the display.

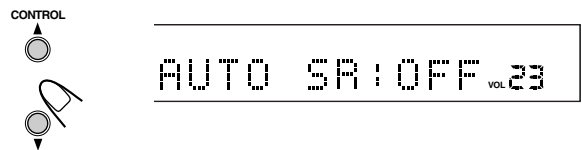

\* “OFF” is the initial setting. If you have already changed the setting, “ON” will be shown.

**3** Press CONTROL▶ (or ◀) to select “ON” (or “OFF”).

- Each time you press the button, Auto Surround turns “ON” or “OFF”

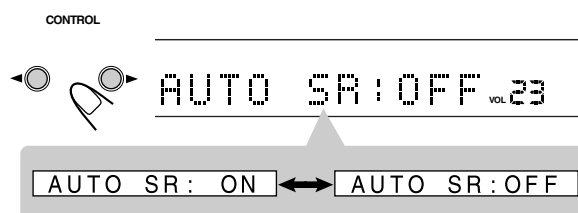



- ON** : The AUTO SR indicator lights up on the display.
- If multichannel signals come in, an appropriate Surround mode will be turned on.
  - If Dolby Digital 2ch or DTS 2ch signals including surround signals come in, “PL II MOVIE” will be selected.
  - If Dolby Digital 2ch or DTS 2ch signals not including surround signals come in, “STEREO” will be selected.
  - If Linear PCM signals come in, nothing will change.
- OFF** : Select this to deactivate Auto Surround.

**Notes:**

- This function does not take effect in the following cases:
  - While playing an analogue source.
  - While selecting “DGTL D.D.” or “DGTL DTS” as the fixed digital input mode (see pages 13 and 14).
- If Surround mode is automatically activated by Auto Surround, another Surround mode in use will be canceled temporarily. When multichannel digital signals stop coming in, the selected Surround mode is canceled, and the previous Surround mode resumes.
- If you press SURROUND ON/OFF or SURROUND MODE with Auto Surround activated, Auto Surround will be canceled temporarily for the currently selected source. Auto Surround setting will be restored in the following cases:
  - When you turn off and on the unit,
  - When you change the source,
  - When you change the analogue/digital input, and
  - When you reset “AUTO SR” to “ON” again.

**To cancel Auto Surround**

Repeat steps **1** and **2**, then select “OFF” in step **3**.

## Setting the Auto Function Mode

You can activate Auto Function mode.

- This function takes effect only when the video components and TV are connected to this unit with SCART cables.
- This function takes effect for the following sources—DVD, STB, and VCR.

**Before you start, remember...**

There is a time limit in doing the following steps. If the setting is canceled before you finish, start from step **1** again.

**1 Press SETTING.**

SETTING



The CONTROL buttons now work for basic settings.

**2 Press CONTROL ▼ (or ▲) repeatedly until “MODE” (with the current setting)\* appears on the display.**

CONTROL



MODE: MANUAL VOL. 23

\* “MANUAL” is the initial setting. If you have already changed the setting, another mode will be shown.

**3 Press CONTROL ► (or ◀) to select “AUTO1” or “AUTO2.”**

- Each time you press the button, Auto Function mode changes as follows:

CONTROL



MODE: MANUAL VOL. 23

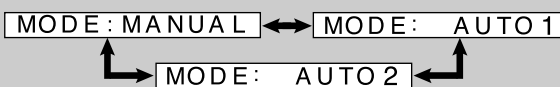

**AUTO1** : When a video component is turned on while the unit is on, the unit selects the video component as the source automatically. The AUTO MODE indicator lights up on the display.

**AUTO2** : • **When a video component is turned on**

- while the unit is off, the unit changes the mode into TV Direct and selects the video component as the source automatically.
- while the unit is on or TV Direct is activated, the unit selects the video component as the source automatically.

• **When a video component is turned off**

- while TV Direct is activated or the unit is on with one of the video components selected, the unit selects the previously selected video component as the source automatically. (If all the video components are turned off, the unit will be turned off automatically.)

The AUTO MODE indicator lights up on the display.

**MANUAL** : Select the source manually.

**Notes:**

- When selecting VCR as the source, “AUTO1” or “AUTO2” may not work if you only turn on the VCR. If it happens, you may need to start playback to activate Auto Function mode.
- When video components are selected at the same time, DVD is selected rather than STB and VCR, and STB is selected rather than VCR.

# Sound Adjustments

You can also use the remote control for some sound adjustments.

- When using the remote control, see also “Mastering Remote Operations” on page 38.

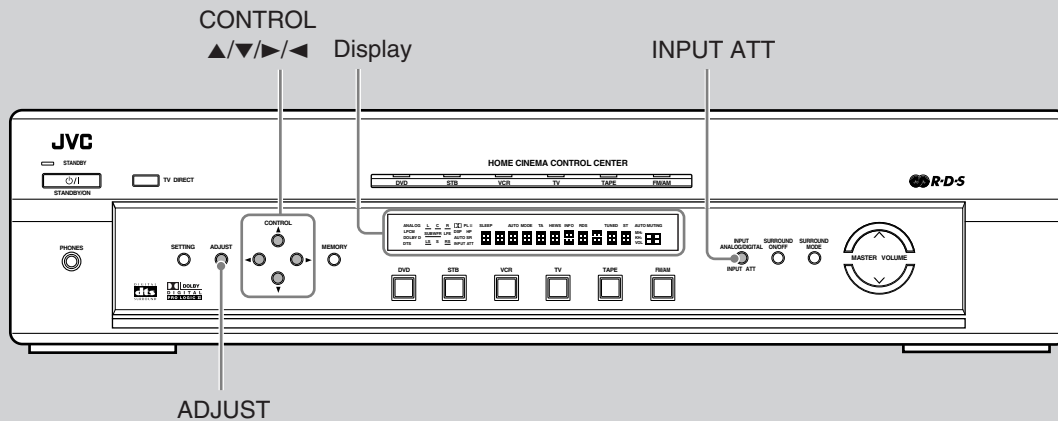

## Attenuating the Input Signal



When the input level of the **analogue source** is too high, the sounds will be distorted. If this happens, you need to attenuate the input signal level to prevent the sound distortion.

- You have to make this adjustment for each **analogue source**.

Press and hold **INPUT ATT (INPUT ANALOG/DIGITAL)** so that the **INPUT ATT indicator lights up on the display**.

- Each time you press and hold the button, the Input Attenuator turns on (“ATT ON”) or off (“ATT NORMAL”).

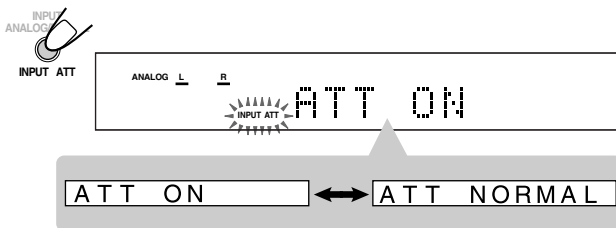

- 2 Press **CONTROL ▼** (or **▲**) repeatedly until **“BAL (Balance)”** (with the current setting)\* appears on the display.

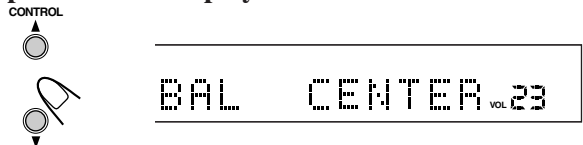

- \* “CENTER” is the initial setting. If you have already changed the setting, another setting will be shown.

- 3 Press **CONTROL ►** (or **◄**) to adjust the front speaker balance.

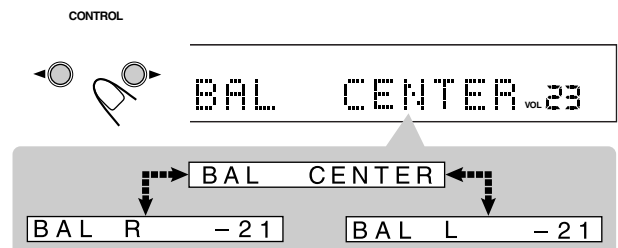

- Pressing **CONTROL ►** decreases the left channel output (from CENTER to L -21).
- Pressing **CONTROL ◄** decreases the right channel output (from CENTER to R -21).

## Adjusting the Front Speakers Output Balance



If the sounds you hear from the front right and left speakers are unequal, you can adjust the speakers output balance.

- You have to make this adjustment for each source.

**Before you start, remember...**

There is a time limit in doing the following steps. If the setting is canceled before you finish, start from step **1** again.

- 1 Press **ADJUST**.



The **CONTROL** buttons now work for sound adjustments.



## Reinforcing the Bass

You can boost the bass level—Bass Boost.

- You have to make these adjustments for each source.

**Before you start, remember...**

There is a time limit in doing the following steps. If the setting is canceled before you finish, start from step **1** again.

### 1 Press ADJUST.



The CONTROL buttons now work for sound adjustments.

### 2 Press CONTROL ▼ (or ▲) repeatedly until “B. BOOST (Bass Boost)” (with the current setting)\* appears on the display.



\* “OFF” is the initial setting. If you have already changed the setting, “ON” will be shown.

### 3 Press CONTROL ► (or ◀) to turn Bass Boost “ON” or “OFF.”

CONTROL

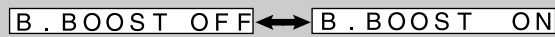
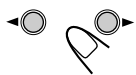

**ON** : Select this to boost the bass level (Bass Boost).

**OFF** : Select this to deactivate Bass Boost.

**Note:**

This function affects the sound outputting only through the front speakers.

**When using the remote control**

Press BASS BOOST.

- Each time you press the button, Bass Boost turns on and off alternately.

## Adjusting the Tone

You can adjust the bass and treble sounds as you like.

- You have to make these adjustments for each source.

**Before you start, remember...**

There is a time limit in doing the following steps. If the setting is canceled before you finish, start from step **1** again.

### 1 Press ADJUST.



The CONTROL buttons now work for sound adjustments.

### 2 Press CONTROL ▼ (or ▲) repeatedly until “BASS” or “TREBLE” (with the current setting)\* appears on the display.

CONTROL

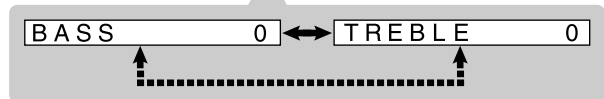

**BASS** : To adjust the bass.

**TREBLE** : To adjust the treble.

\* “0” is the initial setting. If you have already changed the setting, another number (level) will be shown.

### 3 Press CONTROL ► (or ◀) to adjust the sound level.

CONTROL

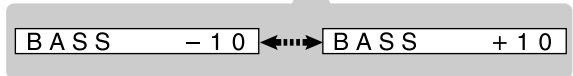
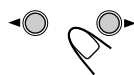

Ex.: When adjusting the bass level.

- Pressing CONTROL ► increases the sound level by 2 steps (from -10 to +10).
- Pressing CONTROL ◀ decreases the sound level by 2 steps (from +10 to -10).

### 4 Repeat steps 2 and 3 to adjust the other sound level.

**When using the remote control**

**1** Press SOUND.

10 keys now work for sound adjustments.

**2** Press BASS +/- or TREBLE +/- to adjust the sound level (from -10 to +10).

# Sound Adjustments

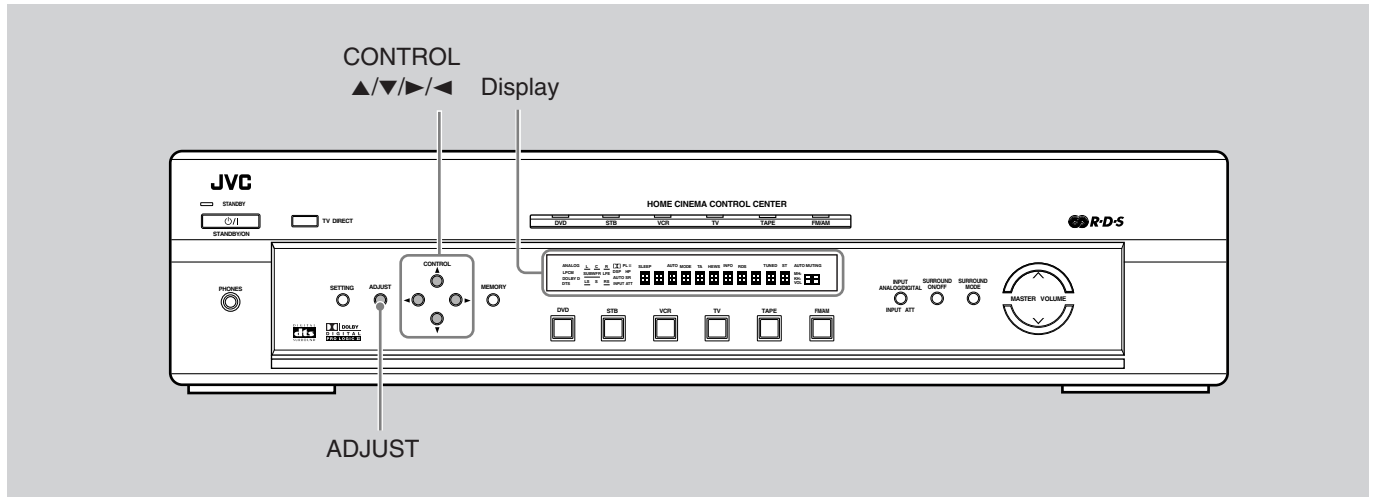

## Adjusting the Subwoofer Output Level

You can adjust the subwoofer output level if you have connected a subwoofer and set the subwoofer information correctly—"YES" (see page 15).

- You have to make this adjustment for each source.

### Before you start, remember...

There is a time limit in doing the following steps. If the setting is canceled before you finish, start from step 1 again.

#### 1 Press ADJUST.



The CONTROL buttons now work for sound adjustments.

#### 2 Press CONTROL ▼ (or ▲) repeatedly until "SUBWFR (subwoofer)" (with the current setting)\* appears on the display.

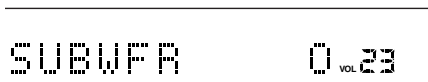

#### 3 Press CONTROL ▶ (or ◀) to adjust the sound output level.

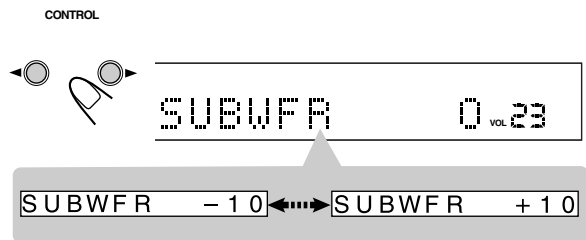

- Pressing CONTROL ▶ increases the sound output level (from -10 to +10).
- Pressing CONTROL ◀ decreases the sound output level (from +10 to -10).

### When using the remote control

- 1 Press SOUND. 10 keys now work for sound adjustments.
- 2 Press SUBWOOFER +/- to adjust the sound output level (from -10 to +10).

\* "0" is the initial setting. If you have already changed the setting, another number (level) will be shown.

# Tuner Operations

You can also use the remote control for some tuner operations.

- When using the remote control, see also “Mastering Remote Operations” on page 38.

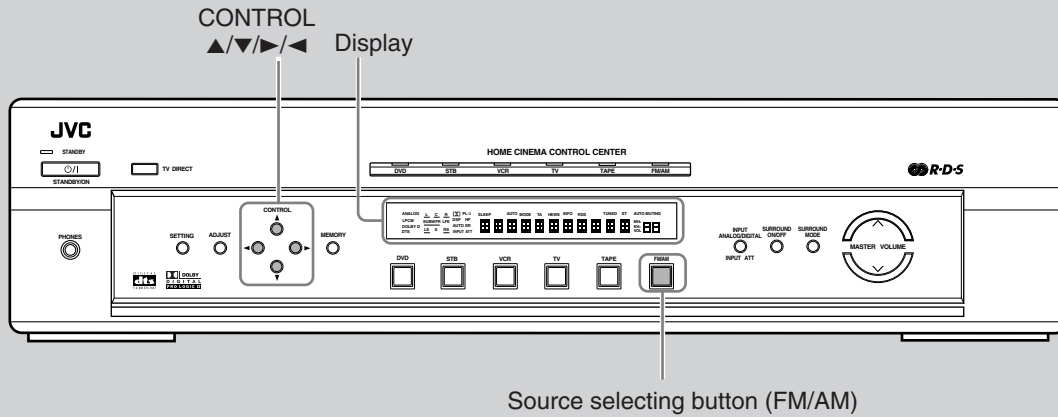

## Tuning into Stations Manually

### 1 Press FM/AM to select the band.

The last received station of the selected band is tuned in, and the CONTROL buttons now work for tuner operations.

- Each time you press the button, the band alternates between FM and AM (MW/LW).

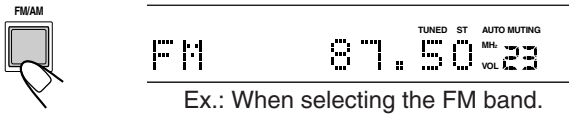

### 2 Press CONTROL ▼ (or ▲) repeatedly until “< TUNING >” appears on the display.

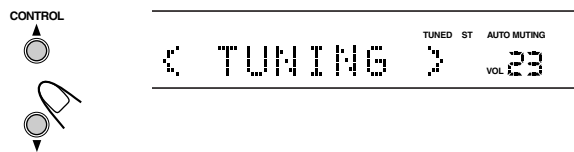

### 3 While “< TUNING >” still remains on the display, press repeatedly or hold CONTROL ► (or ◀) until you find the frequency you want.

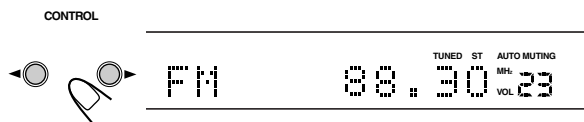

- Pressing (or holding) CONTROL ► increases the frequencies.
- Pressing (or holding) CONTROL ◀ decreases the frequencies.

## When using the remote control

- 1 Press FM or AM.
- 2 Press repeatedly or hold TUNING UP or DOWN until you find the frequency you want.
  - Pressing (or holding) TUNING UP increases the frequencies.
  - Pressing (or holding) TUNING DOWN decreases the frequencies.

## Notes:

- When you hold and release CONTROL ► (or TUNING UP on the remote control) or CONTROL ◀ (or TUNING DOWN on the remote control), the frequency keeps changing until a station is tuned in.
- When a station of sufficient signal strength is tuned in, the TUNED indicator lights up on the display.
- When an FM stereo program is received, the ST (Stereo) indicator also lights up.

# Tuner Operations

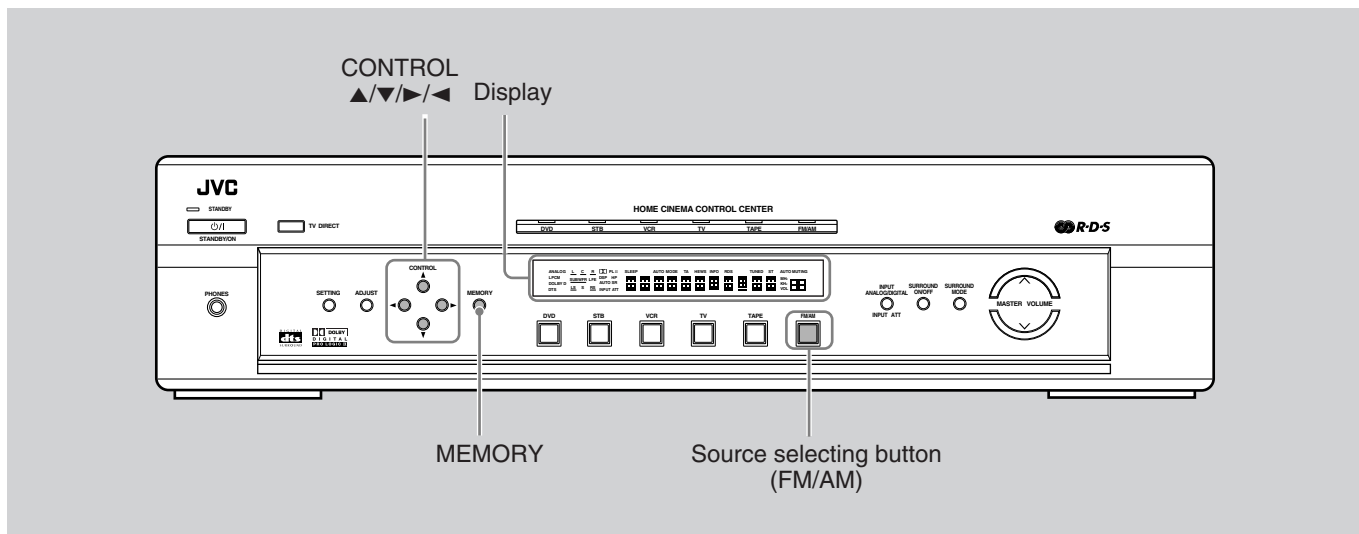

## Using Preset Tuning

Once a station is assigned to a channel number, the station can be quickly tuned. You can preset up to 30 FM and 15 AM (MW/LW) stations.

### To store the preset stations

Before you start, remember...

There is a time limit in doing the following steps. If the setting is canceled before you finish, start from step 2 again.



### 1 Tune into the station you want to preset (see “Tuning into Stations Manually” on page 23).

- If you want to store the FM reception mode for this station, select the FM reception mode you want. See “Selecting the FM Reception Mode” on page 25.



### 2 Press MEMORY.

The channel number position starts flashing on the display for about 5 seconds.



### 3 Press CONTROL ► (or ◀) to select a channel number while the channel number position is flashing.

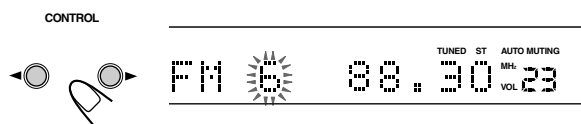

### 4 Press MEMORY again while the selected channel number is flashing on the display.

The station is assigned to the selected channel number.

- The selected channel number stops flashing and then the frequency starts flashing.

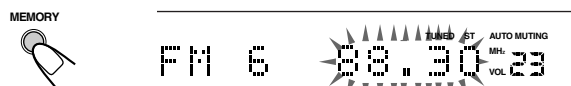

### 5 Press CONTROL ► (or ◀) to select another frequency you want to store while the frequency flashes on the display.

### 6 Repeat steps 1 to 5 until you store all the stations you want.

### To erase a stored preset station

Storing a new station on a used channel number erases the previously stored one.

## To tune in a preset station

### 1 Press FM/AM to select the band.

The last received station of the selected band is tuned in, and the CONTROL buttons now work for tuner operations.



Ex.: When selecting the FM band.

### 2 Press CONTROL ▼ (or ▲) repeatedly until “< PRESET >” appears on the display.



### 3 While “< PRESET >” still remains on the display, press CONTROL ► (or ◀) to select a preset channel number you want.

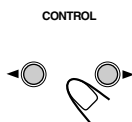

- Pressing (or holding) CONTROL ► increases the preset channel numbers.
- Pressing (or holding) CONTROL ◀ decreases the preset channel numbers.

## When using the remote control

### 1 Press FM or AM.

The last received station of the selected band is tuned in, and the 10 keys now work for tuner operations.

### 2 Press the 10 keys to select a preset channel number.

- For channel number 5, press 5.
- For channel number 15, press +10 then 5.
- For channel number 30, press +10, +10, then 10.

## Selecting the FM Reception Mode

When an FM stereo broadcast is hard to receive or noisy, you can change the FM reception mode while receiving an FM broadcast.

- You can store the FM reception mode for each preset station (see page 24).

### Before you start, remember..

There is a time limit in doing the following steps. If the setting is canceled before you finish, start from step 1 again.

### 1 While listening to an FM station, press CONTROL ▼ (or ▲) repeatedly until “< FM MODE >” appears on the display.



### 2 Press CONTROL ► (or ◀) to select “MONO.”

- Each time you press the button, the FM reception mode alternates between “AUTO MUTING”\* and “MONO.”

CONTROL

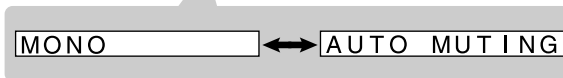

- \* “AUTO MUTING” is the initial setting. If you have already changed the setting, “MONO” will be shown.

### AUTO MUTING : Normally select this.

When a program is broadcasted in stereo, you will hear stereo sound; when in monaural, you will hear monaural sounds. This mode is also useful to suppress static noise between stations. The AUTO MUTING indicator lights up on the display.

**MONO** : Select this to improve the reception (but stereo effect will be lost). In this mode, you will hear noise while tuning into the stations. The AUTO MUTING indicator goes off from the display. (The ST indicator also goes off.)

## To restore the stereo effect

Repeat step 1, then select “AUTO MUTING” in step 2.

## When using the remote control

### 1 Press FM.

10 keys now work for tuner operations.

### 2 Press FM MODE.

- Each time you press the button, the FM reception mode alternates between “AUTO MUTING” and “MONO.”

# Tuner Operations

You need to set RDS/DVD MENU selector to "RDS," when you want to operate RDS.

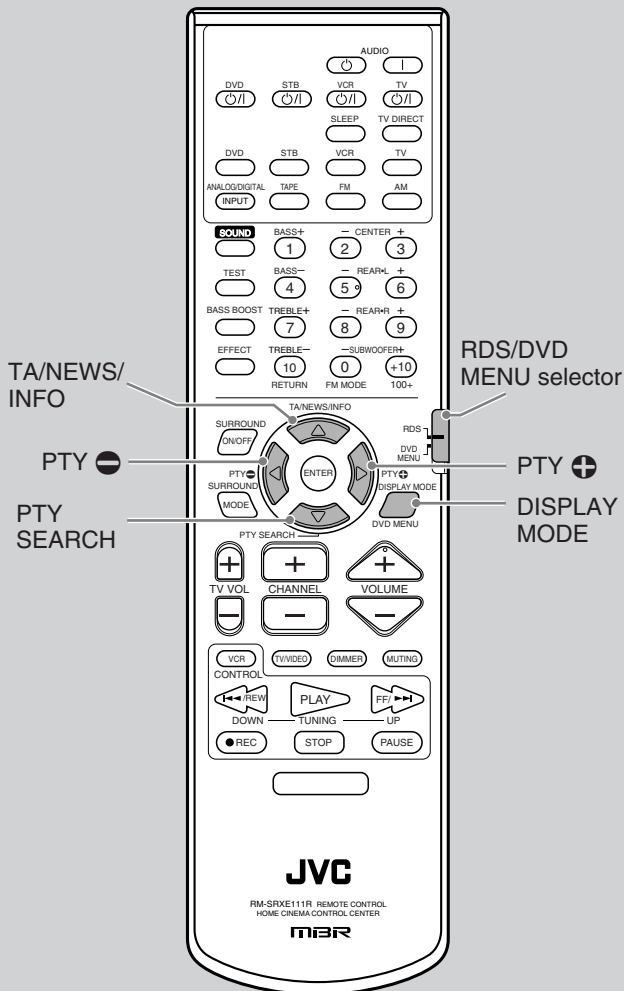

With the unit, you can receive the following types of RDS signals:

- PS (Program Service):** Shows commonly known station names.
- PTY (Program Type):** Shows types of broadcast programs.
- RT (Radio Text):** Shows text messages the station sends.
- Enhanced Other Network:** See page 29.

**Notes:**

- RDS is not available for AM (MW/LW) broadcasts.
- RDS may not operate correctly if the station tuned is not transmitting RDS signal properly or if the signal strength is weak.

## What information can RDS signals provide?

You can see the RDS signals the station sends on the display.

### To show the RDS signals

1 Set RDS/DVD MENU selector to "RDS."

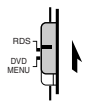

2 Press DISPLAY MODE while listening to an FM station.



- Each time you press the button, the display changes to show you the following information:

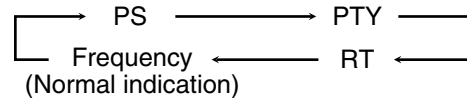

### PS (Program Service):

While searching, "PS" appears and then the station names will be displayed. "NO PS" appears if no signal is sent.

### PTY (Program Type):

While searching, "PTY" appears and then the type of the broadcast program will be displayed. "NO PTY" appears if no signal is sent.

### RT (Radio Text):

While searching, "RT" appears and then text messages the station sends will be displayed. "NO RT" appears if no signal is sent.

### Frequency:

Station frequency (non-RDS service).

## Using the RDS (Radio Data System) to Receive FM Stations



RDS allows FM stations to send an additional signal along with their regular program signals. For example, the stations send their station names, as well as information about what type of program they broadcast, such as sports or music, etc.

When tuned to an FM station which provides the RDS service, the RDS indicator lights up on the display.

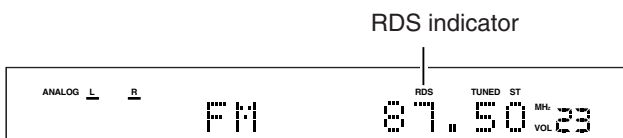

### About characters shown on the display

When the display shows PS, PTY, or RT signals, the following characters are used:

- The display cannot differentiate upper case and lower case letters and always uses upper case letters.
- The display cannot show accented letters, "A," for instance, may stand for accented "A's" like "À, Ä, Ã, Á, À, Â, ã, ä, ã, à, ù, and â."

**Note:**

If searching finishes at once, "PS," "PTY," and "RT" will not appear on the display.

## Searching for a Program by PTY Codes



One of the advantages of the RDS service is that you can locate a particular kind of program from the preset channels (see page 24) by specifying the PTY codes.

### To search for a program using the PTY codes

Before you start, remember...

- The PTY Search is only applicable to preset stations.
- To stop searching any time during the process, press PTY SEARCH while searching.
- There is a time limit in doing the following steps. If the setting is canceled before you finish, start from step 1 again.

**1** Set RDS/DVD MENU selector to "RDS."



**2** Press PTY SEARCH while listening to an FM station.

"PTY SELECT" flashes on the display.



**3** Press PTY + or PTY - until the PTY code you want appears on the display, while "PTY SELECT" is flashing.

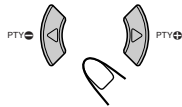

- For details, see "Description of the PTY codes" on page 28.

**4** Press PTY SEARCH again, while the PTY code selected in the previous step is still on the display.



While searching, "SEARCH" and the selected PTY code alternate on the display.

The unit searches 30 preset FM stations, stops when it finds the one you have selected, and tunes in that station.

### PTY codes



### To continue searching after the first stop

Press PTY SEARCH again while the indications on the display are flashing.

If no program is found, "NOT FOUND" appears on the display.

# Tuner Operations

You need to set RDS/DVD MENU selector to "RDS," when you want to operate RDS.

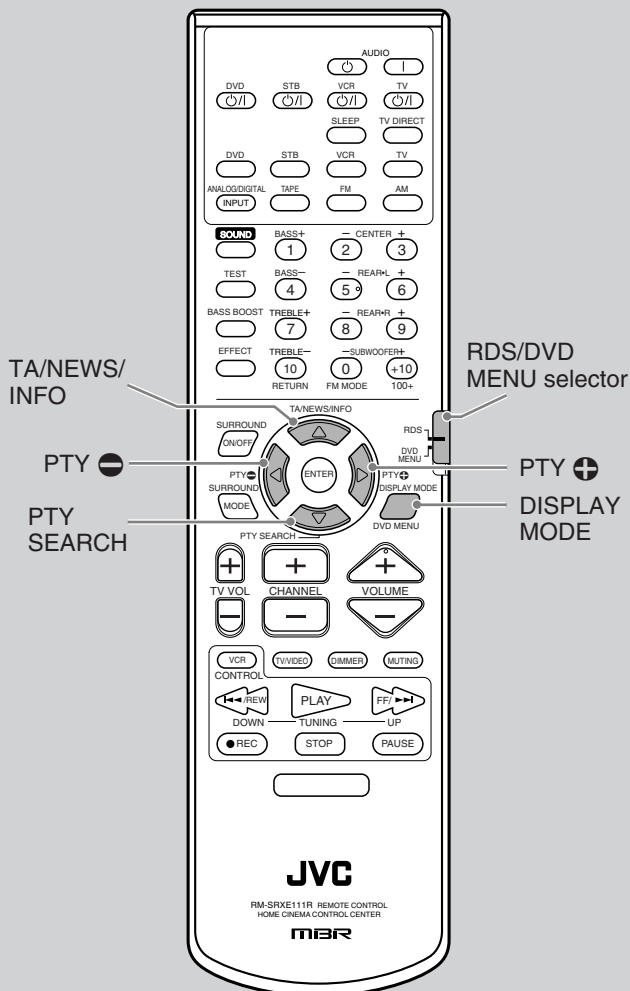

## Description of the PTY codes:

<b>NEWS:</b>	News.
<b>AFFAIRS:</b>	Topical program expanding or enlarging upon the news—debate, or analysis.
<b>INFO:</b>	Programs the purpose of which is to impart advice in the widest sense.
<b>SPORT:</b>	Programs concerned with any aspect of sports.
<b>EDUCATE:</b>	Educational programs.
<b>DRAMA:</b>	All radio plays and serials.
<b>CULTURE:</b>	Programs concerning any aspect of national or regional culture, including language, theater, etc.
<b>SCIENCE:</b>	Programs about natural sciences and technology.
<b>VARIED:</b>	Used for mainly speech-based programs such as quizzes, panel games and personality interviews.
<b>POP M:</b>	Commercial music of current popular appeal.
<b>ROCK M:</b>	Rock music.
<b>EASY M:</b>	Current contemporary music considered to be "easy-listening."
<b>LIGHT M:</b>	Instrumental music, and vocal or choral works.
<b>CLASSICS:</b>	Performances of major orchestral works, symphonies, chamber music, etc.
<b>OTHER M:</b>	Music not fitting into any of the other categories.
<b>WEATHER:</b>	Weather reports and forecasts.
<b>FINANCE:</b>	Stock Market reports, commerce, trading etc.
<b>CHILDREN:</b>	Programs targeted at a young audience.
<b>SOCIAL:</b>	Programs about sociology, history, geography, psychology and society.
<b>RELIGION:</b>	Religious programs.
<b>PHONE IN:</b>	Involving members of the public expressing their views either by phone or at a public forum.
<b>TRAVEL:</b>	Travel information.
<b>LEISURE:</b>	Programs about recreational activities.
<b>JAZZ:</b>	Jazz music.
<b>COUNTRY:</b>	Songs which originate from, or continue the musical tradition of the American Southern States.
<b>NATION M:</b>	Current popular music of the nation or region in that country's language.
<b>OLDIES:</b>	Music from the so-called "golden age" of popular music.
<b>FOLK M:</b>	Music which has its roots in the musical culture of a particular nation.
<b>DOCUMENT:</b>	Programs concerning factual matters, presented in an investigative style.
<b>TEST:</b>	Broadcasts for testing emergency broadcast equipment or unit.
<b>ALARM:</b>	Emergency announcement.

Classification of the PTY codes for some FM stations may be different from the above list.



## Switching to Broadcast Program of Your Choice Temporarily



Another convenient RDS service is called “Enhanced Other Network.” This allows the unit to switch temporarily to a broadcast program of your choice (TA, NEWS, and/or INFO) from a different station except in the following cases:

- When you are listening to non-RDS stations (all AM—MW/LW stations, some FM stations and other sources).
- When the unit is in standby mode or in TV Direct.

### Before you start, remember...

The Enhanced Other Network function is only applicable to preset stations.

**1** Set RDS/DVD MENU selector to “RDS.”

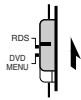

**2** Press TA/NEWS/INFO repeatedly until the program type you want appears on the display.

- Each time you press the button, the display changes to show the following:

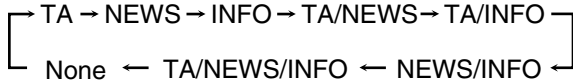

<b>TA</b>	: Traffic Announcement in your area.
<b>NEWS</b>	: News.
<b>INFO</b>	: Program the purpose of which is to impart advice in the widest sense.

### How the Enhanced Other Network function actually works:

#### CASE 1

**If there is no station broadcasting the program you have selected**

The unit continues tuning in the current station.



When a station starts broadcasting the program you have selected, the unit automatically switches to the station. The indicator of received PTY code starts flashing.



When the program is over, the unit goes back to the previously tuned station, but the Enhanced Other Network function still remains activated.

#### CASE 2

**If the FM station you are listening to is broadcasting the program you have selected**

The unit continues to receive the station but the indicator of received PTY code starts flashing.



When the program is over, the indicator of received PTY code stops flashing and remains lit, but the Enhanced Other Network function still remains activated.

**To stop listening to the program selected by Enhanced Other Network.**

Press TA/NEWS/INFO repeatedly again so that the program type (TA/NEWS/INFO) indicator goes off from the display. The unit exits from Enhanced Other Network standby mode and goes back to the previously selected station.

**When an emergency broadcast (ALARM signal) is sent from an FM station.**

The unit automatically tunes in the station except in the following cases:

- When you are listening to non-RDS stations (all AM—MW/LW stations, some FM stations and other sources).
- When the unit is in standby mode or TV Direct.

While receiving an emergency broadcast, “ALARM” appears on the display.

**The TEST signal is used for equipment test—whether it can receive the ALARM signal correctly.**

The TEST signal makes the unit work in the same way as the ALARM signal does. If the TEST signal is received, the unit automatically switches to the station broadcasting the TEST signal. While receiving the TEST signal, “TEST” appears on the display.

#### Notes:

- Enhanced Other Network data sent from some stations may not be compatible with this unit.
- Enhanced Other Network does not function for some FM stations with RDS service.
- While listening to a program tuned in by the Enhanced Other Network function, the station does not change even if another network station starts broadcasting a program of the same Enhanced Other Network data.
- While listening to a program tuned in by the Enhanced Other Network function, you can only use the TA/NEWS/INFO and DISPLAY MODE as the tuner operation buttons.
- If the stations alternate intermittently between the station tuned by the Enhanced Other Network function and the currently tuned station, press TA/NEWS/INFO repeatedly to cancel the Enhanced Other Network function.  
If you do not press the button, the currently tuned station is received finally, and the indication of the Enhanced Other Network data type flashing on the display disappears.

# Creating Realistic Sound Fields

You can use the following Surround modes to reproduce a realistic sound field:

- Dolby Surround
  - Dolby Pro Logic II
  - Dolby Digital
- DTS Digital Surround
- DAP (Digital Acoustic Processor) modes
- All Channel Stereo

## ■ Dolby Surround

### Dolby Pro Logic II\*

**Dolby Pro Logic II** has newly developed multichannel playback format to decode all 2 channel sources—stereo source and Dolby Surround encoded source—into 5.1 channel.

Matrix-based encoding/decoding method for Dolby Pro Logic II makes no limitation for the cutoff frequency of the rear treble and enables stereo rear sound compared to conventional Dolby Pro Logic.

Dolby Pro Logic II enables to reproduce spacious sound from original sound without adding any new sounds and tonal colorations. Dolby Pro Logic II has two modes—**Movie mode** and **Music mode**:

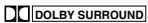
**Pro Logic II Movie**—suitable for reproduction of Dolby Surround encoded sources bearing the mark . You can enjoy sound field very close to the one created with discrete 5.1-channel sounds.

**Pro Logic II Music**—suitable for reproduction of any 2-channel stereo music sources. You can enjoy wide and deep sound by using this mode. For this mode, Panorama control can be selected, which gives “wraparound” sound effect with side-wall image.

- When Dolby Pro Logic II is activated, the  PL II indicator lights up on the display.

### Dolby Digital\*

Used to reproduce multichannel sound tracks of the software encoded with Dolby Digital (  ).

- To enjoy the software encoded with Dolby Digital, connect the source component using the digital terminal on the rear of this receiver. (See page 7.)

**Dolby Digital 5.1-channel** encoding method (so-called discrete multichannel digital audio format) records and digitally compresses the left front channel, right front channel, center channel, left rear channel, right rear channel, and LFE channel signals.

Since each channel is completely independent from the other channel signals to avoid interference, you can obtain much better sound quality with much stereo and surround effects.

### Note:

*Dolby Digital software can be roughly grouped into two categories—multichannel (up to 5.1-channel) and 2-channel software. To enjoy surround sounds while playing Dolby Digital 2-channel software, you can use Dolby Pro Logic II.*

## ■ DTS Digital Surround\*\*

Used to reproduce multichannel sound tracks of the software encoded with DTS Digital Surround (  ).

- To enjoy the software encoded with DTS Digital Surround, connect the source component using the digital terminal on the rear of this receiver. (See page 7.)

**DTS Digital Surround** is another discrete multichannel digital audio format available on CD, LD, and DVD software. Compared to Dolby Digital, audio compression ratio is relatively low. This fact allows DTS Digital Surround format to add breadth and depth to the reproduced sounds. As a result, DTS Digital Surround features natural, solid and clear sound.

## Typical Multichannel (5.1-channel) reproduction

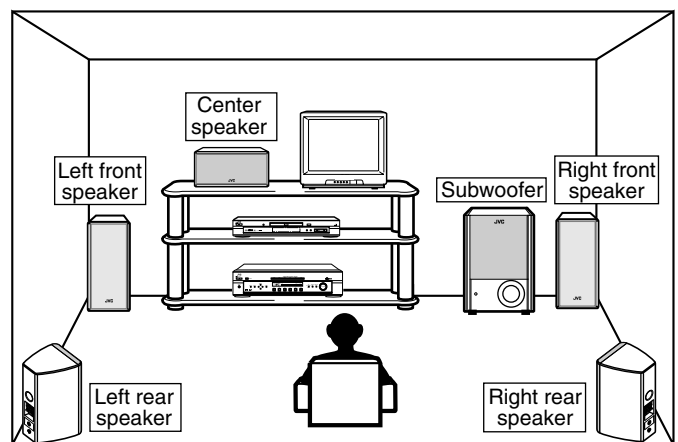

\* Manufactured under license from Dolby Laboratories. “Dolby,” “Pro Logic,” and the double-D symbol are trademarks of Dolby Laboratories.

\*\* Manufactured under license from Digital Theater Systems, Inc. US PAT. No. 5,451,942 and other world-wide patents issued and pending. “DTS” and “DTS Digital Surround” are trademarks of Digital Theater Systems, Inc. Copyright 1996 Digital Theater Systems, Inc. All Rights Reserved.

### ■ DAP (Digital Acoustic Processor) modes

DAP modes have been designed to create important acoustic surround elements.

The sound heard in a live club, dance club, hall or pavilion consists of direct sound and indirect sound—early reflections and reflections from behind. Direct sounds reach the listener directly without any reflection. On the other hand, indirect sounds are delayed by the distances of the ceiling and walls (see the diagram below).

These indirect sounds are important elements of the acoustic surround effects. The DAP mode can reproduce a realistic sound field by adding these indirect sounds.

**DAP modes can be used when the front and rear speakers are connected to this receiver (without respect to the center speaker connection: no sound comes out of the center speaker even if it is connected).**

The following DAP modes are provided with this receiver:

<b>LIVE CLUB</b>	: Gives the feeling of a live music club with a low ceiling.
<b>DANCE CLUB</b>	: Gives a throbbing bass beat.
<b>HALL</b>	: Gives clear vocal and the feeling of a concert hall.
<b>PAVILION</b>	: Gives the spacious feeling of a pavilion with a high ceiling.

These DAP modes can be used to add the acoustic surround effects while reproducing 2-channel stereo software, either analogue or Linear PCM digital signal, and can give you a real “being there” feeling.

- When one of the DAP modes is selected, the DSP indicator lights up on the display.

#### Creating sound field

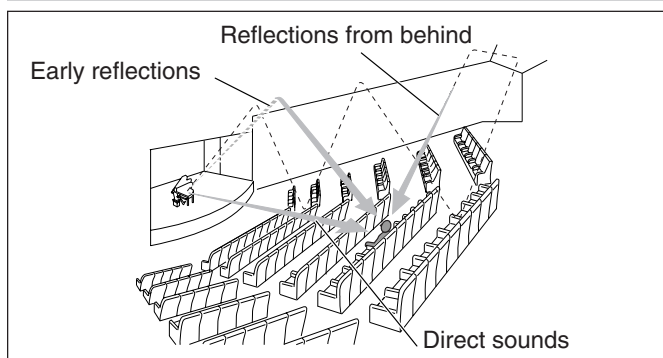

### ■ All Channel Stereo

This mode can reproduce a larger stereo sound field using all the connected (and activated) speakers.

**All Channel Stereo can be used when the front and rear speakers are connected to this receiver without respect to the center speaker connection.**

If the center speaker is connected and activated, the same phase of the front left and right signals are mixed and output through the center speaker.

All Channel Stereo can be used while reproducing 2-channel stereo software, either analogue or Linear PCM digital signal.

- When All Channel Stereo is selected, the DSP indicator lights up on the display.

#### All Channel Stereo reproduction

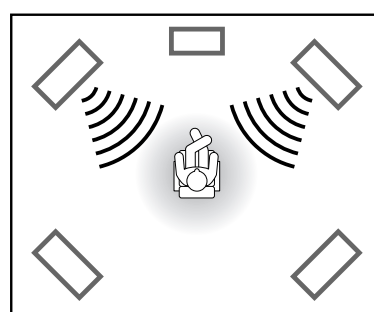

Sound reproduced from normal stereo

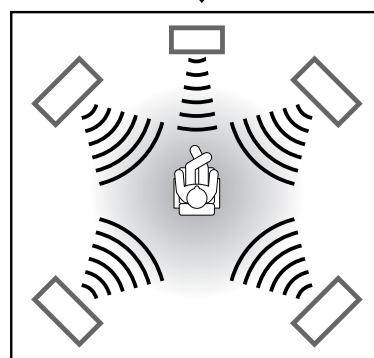

Sound reproduced from All Channel Stereo

#### Available Surround modes for each input signal

○: Possible ×: Impossible

Mode Signals	STEREO	DOLBY DIGITAL	DTS SURROUND	PROLOGIC II MOVIE	PROLOGIC II MUSIC	LIVE CLUB	DANCE CLUB	HALL	PAVILION	ALL CH STEREO
Dolby Digital (Multi-channel)	○	○	×	×	×	×	×	×	×	×
Dolby Digital (2-channel)	○	×	×	○	○	×	×	×	×	×
DTS Digital Surround (Multi-channel)	○	×	○	×	×	×	×	×	×	×
DTS Digital Surround (2-channel)	○	×	×	○	○	×	×	×	×	×
Linear PCM	○	×	×	○	○	○	○	○	○	○
Analogue	○	×	×	○	○	○	○	○	○	○





# Creating Realistic Sound Fields

## About Relations between Speaker Layout and Surround Modes

Available Surround modes will vary depending on how many speakers are used with this unit.

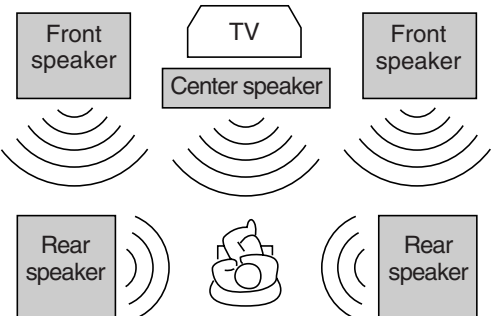
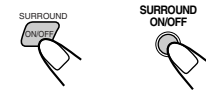
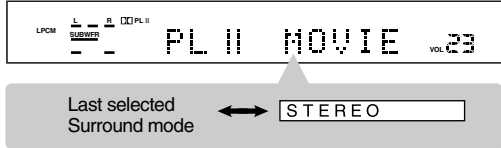
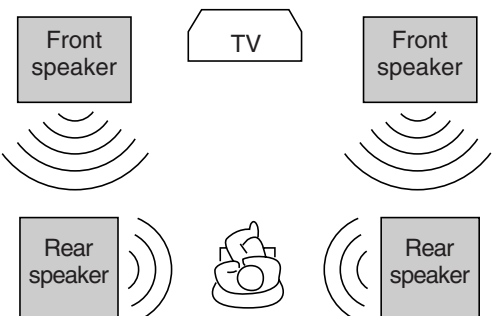
Make sure that you have set the speaker information correctly (see page 15).

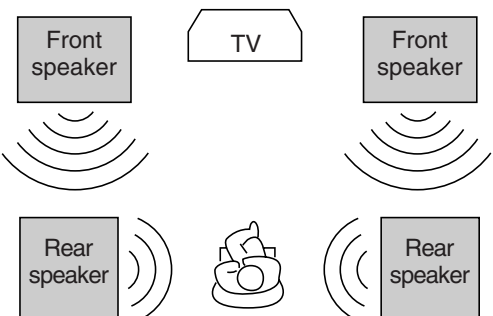
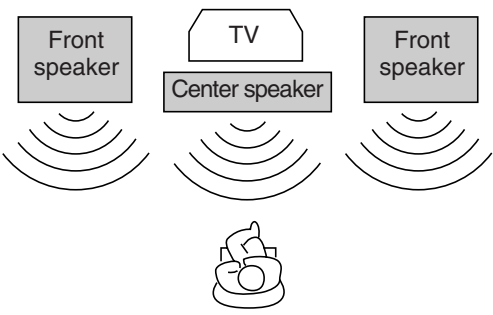
- If only front speakers are connected, you cannot use the Surround modes.
- If rear speakers are not connected, you cannot use DAP modes and the All Channel Stereo.

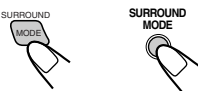
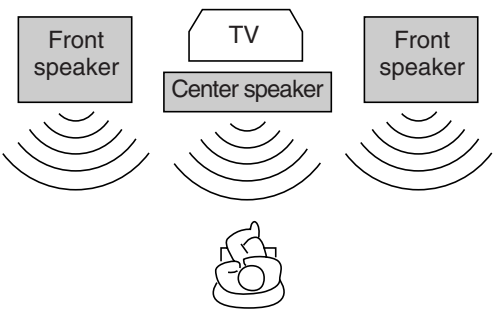
Speaker Layout	Available Surround modes
<p>When the center and rear speakers are connected (5-channel):</p> 	<p><b>Turning on or off the Surround modes</b></p> <p>Each time you press SURROUND ON/OFF, Surround mode turns on or off (“STEREO”).</p>  <p>(Remote) (Front panel)</p>  <p>Ex.: “PL II MOVIE” has been selected.</p>
<p>When the rear speakers are connected (4-channel):</p> 	<p><b>Selecting the Surround modes</b></p> <p>Each time you press SURROUND MODE, Surround modes change as follows:</p>  <p>(Remote) (Front panel)</p> 
<p>When the center speaker is connected (3-channel):</p> 	<p><b>Turning on or off the Surround modes</b></p> <p>Each time you press SURROUND ON/OFF, Surround mode turns on or off (“STEREO”).</p>  <p>(Remote) (Front panel)</p>  <p>Ex.: “PL II MOVIE” has been selected.</p> <p><b>Selecting the Surround modes</b></p> <p>Each time you press SURROUND MODE, Surround modes change as follows:</p>  <p>(Remote) (Front panel)</p> 

When “AUTO SR (Auto Surround)” is turned “ON”

Surround mode is automatically activated when you select and start playing back a multichannel source (see page 18).

It will be convenient for you to use the remote control for Surround adjustments, since you can make adjustments from your listening point, and use the test signal.

- When using the buttons on the front panel, see pages 36 and 37.

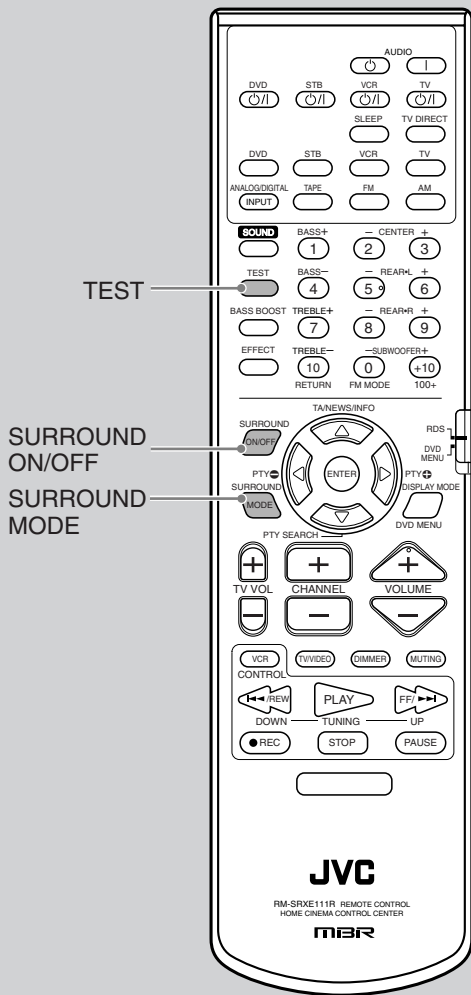

## Using Dolby Pro Logic II, Dolby Digital and DTS Digital Surround (Remote Control)

Once you have adjusted the Surround modes, the adjustment is memorized for each source.

- When playing back digital multichannel software (Dolby Digital 5.1-channel or DTS Digital Surround), the **SURROUND MODE** button does not work.
- For selecting Panorama control for Pro Logic II Music, use the buttons on the front panel.

### 1 Select and play software you like.

### 2 Press SURROUND ON/OFF to activate Surround mode.



Each time you press the button, Surround mode turns on and off alternately.

- If you are playing back **digital multichannel software** such as Dolby Digital 5.1-channel and DTS Digital Surround through the digital input terminal, the appropriate multichannel Surround mode is activated (“DOLBY D” or “DTS”).

→ Go to step 4.

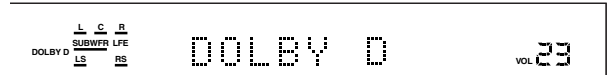

Ex.: When Dolby Digital is activated.

- If you are playing back **any software other than above**, you can activate Pro Logic II.

→ Go to step 3.

If “AUTO SR (Auto Surround)” is set to “ON”  
 Playing a digital source automatically activates an appropriate Surround mode. (See pages 18 and 19.) → Go to step 4.

### 3 Except for the digital multichannel software: Press SURROUND MODE repeatedly to select “PL II MOVIE” or “PL II MUSIC” according to a playing source.



□□ PL II indicator lights up on the display.



### 4 Press TEST to check the speaker output balance.

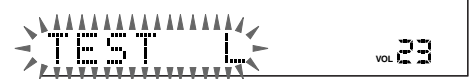

“TEST L” starts flashing on the display, and a test tone comes out of the speakers in the following order:

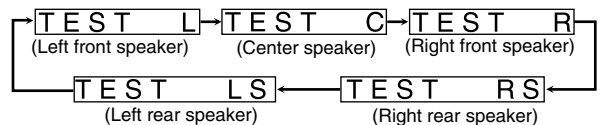

#### Notes:

- You can adjust the speaker output levels without outputting the test tone.
- No test tone comes out of the center speaker when “CNTR SP” is set to “NO.”
- No test tone comes out of the rear speakers when “REAR SP” is set to “NO.”

#### Before you start, remember...

- Make sure that you have set the speaker information correctly (see page 15).
- You cannot adjust the center speaker output level when you have set “CNTR SP” to “NO.”
- You cannot adjust the rear speaker output levels when you have set “REAR SP” to “NO.”
- Remember not to change the speaker setting while using any Surround modes; otherwise, it may be canceled when you deactivate the speakers required for the Surround mode.

TO BE CONTINUED TO THE NEXT PAGE

# Creating Realistic Sound Fields

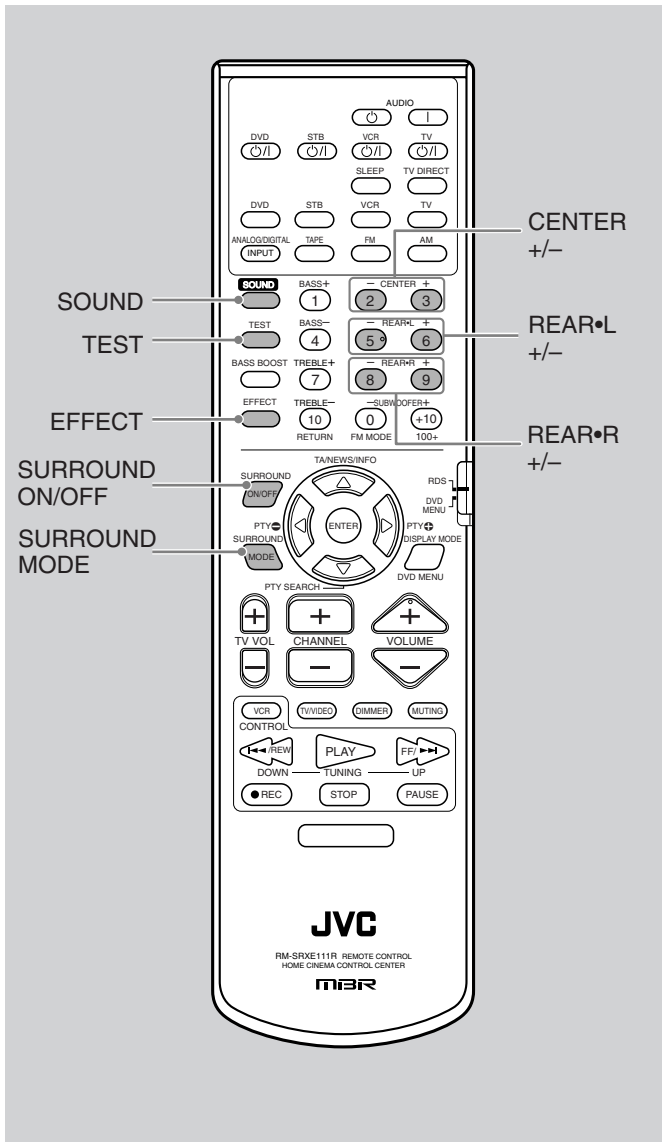

To adjust the center speaker level, press CENTER +/-.

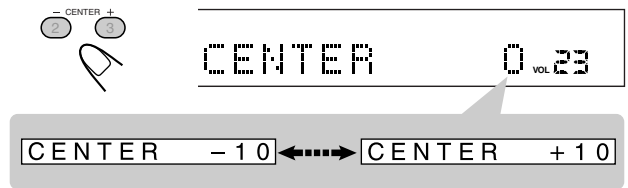

To adjust the left rear speaker level, press REAR•L +/-.

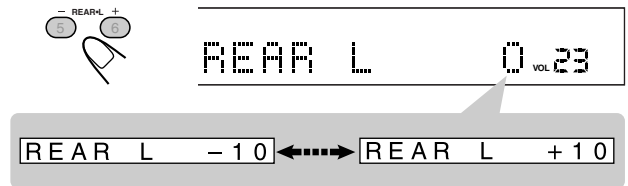

To adjust the right rear speaker level, press REAR•R +/-.

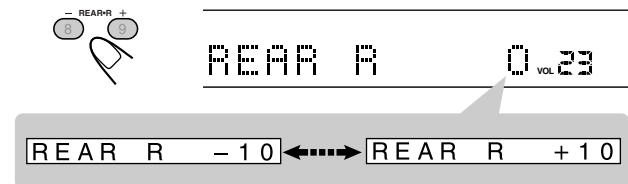

## 7 Press TEST again to stop the test tone.

The currently selected source name appears on the display.

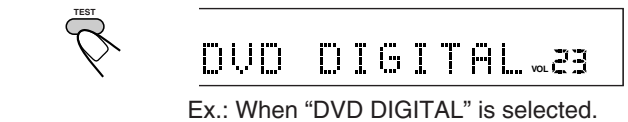

## 5 Press SOUND.



The 10 keys now work for sound adjustments.

## 6 Adjust the following speaker output levels (from -10 to +10).

- Make adjustments so that the sound level of the selected speaker is set at the same level as that of the front speakers.

### To cancel Surround Mode

Press SURROUND ON/OFF again so that "STEREO" appears on the display.

- If Surround mode is canceled while playing back multichannel digital software, all channel signals are mixed and output through the front speakers (and subwoofer if you have connected a subwoofer and set the subwoofer setting correctly—"YES").



## Using DAP Modes and All Channel Stereo (Remote Control)

Once you have adjusted the DAP modes and All Channel Stereo, the adjustment is memorized for each source.

- You cannot use the DAP modes and All Channel Stereo if no rear speakers are connected.
- You cannot adjust the effect level for “ALL CH ST.”

**1 Start playing 2-channel software—either Linear PCM digital or analog signal—and select the source.**

**2 Press SURROUND ON/OFF to activate Surround mode.**

When Surround mode turns on, the last selected Surround mode will be activated.

- Each time you press the button, Surround mode turns on and off alternately.



**3 Press SURROUND MODE repeatedly until one of the DAP modes or “ALL CH ST.” you like to apply appears on the display.**

The DSP indicator also lights up on the display.

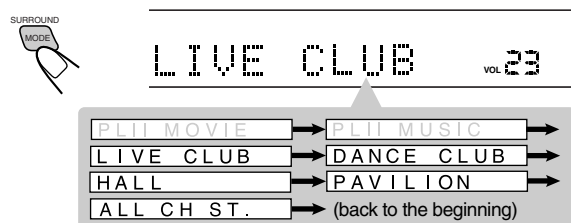

**4 Press SOUND.**

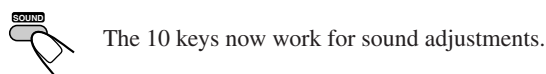

**5 Adjust the rear speaker output levels (from -10 to +10).**

- Make adjustments so that the sound level of the selected speaker is set at the same level as that of the front speakers.

**To adjust the left rear speaker level, press REAR•L +/-.**

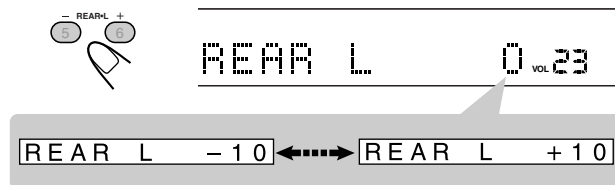

**To adjust the right rear speaker level, press REAR•R +/-.**

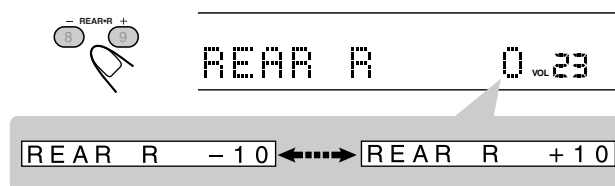

**Only for “ALL CH ST.”: to adjust the center speaker level, press CENTER +/-.**

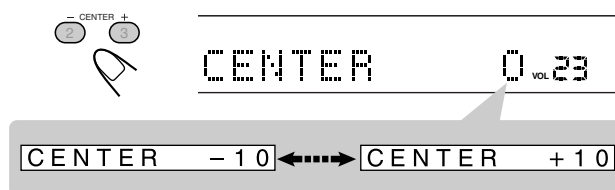

**6 Only for DAP modes:**

**Press EFFECT to select the DAP effect level (1 to 5) you want.**

- As the number increases, the DAP effect becomes stronger (normally set it to “EFFECT 3”).

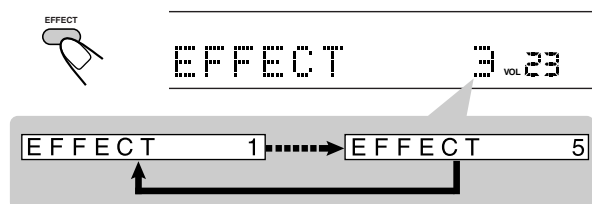

**To cancel DAP Modes and All Channel Stereo**

Press SURROUND ON/OFF so that “STEREO” appears on the display. The DSP indicator goes off.

# Creating Realistic Sound Fields

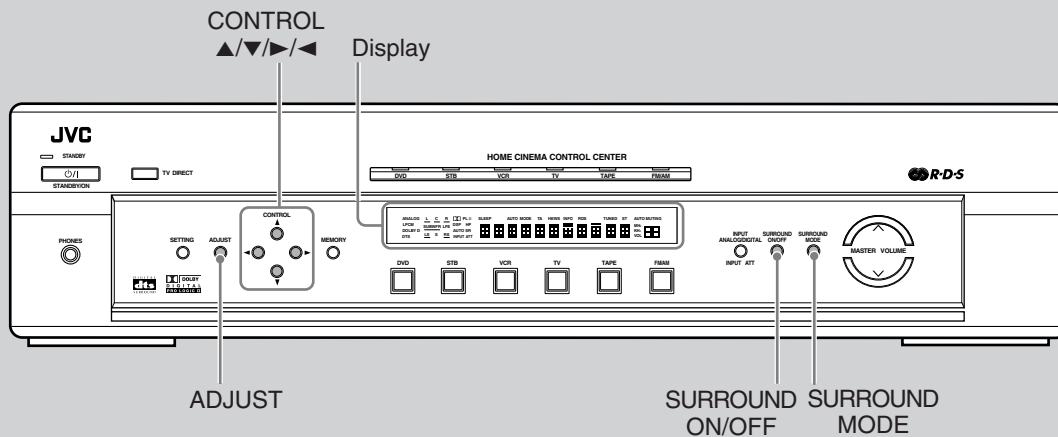

When using the remote control for Surround operations, see pages 33 to 35.

## Before you start, remember...

- Make sure that you have set the speaker information correctly (see page 15).
- You cannot adjust the center speaker output level when you have set "CNTR SP" to "NO."
- You cannot adjust the rear speaker output levels when you have set "REAR SP" to "NO."
- Remember not to change the speaker setting while using any Surround modes; otherwise, it may be canceled when you deactivate the speakers required for the Surround mode.

## Using Dolby Pro Logic II, Dolby Digital and DTS Digital Surround (Front Panel)

Once you have adjusted the Surround modes, the adjustment is memorized for each source.

- When playing back digital multichannel software (Dolby Digital 5.1-channel or DTS Digital Surround), the SURROUND MODE button does not work.
- No test tone is available when using the buttons on the front panel.

### 1 Select and play software you like.

### 2 Press SURROUND ON/OFF to activate Surround mode.

Each time you press the button, Surround mode turns on and off alternately.

- If you are playing back digital multichannel software such as Dolby Digital 5.1-channel and DTS Digital Surround through the digital input terminal, the appropriate multichannel Surround mode is activated ("DOLBY D" or "DTS").  
→ Go to step 4.
- If you are playing back any software other than above, you can activate Pro Logic II.  
→ Go to step 3.

If "AUTO SR (Auto Surround)" is set to "ON" Playing a digital source automatically activates an appropriate Surround mode. (See pages 18 and 19.) → Go to step 4.

- ### 3 Except for the digital multichannel software: Press SURROUND MODE repeatedly to select "PL II MOVIE" or "PL II MUSIC" according to a playing source.
- PL II indicator lights up on the display.

### 4 Press ADJUST.

The CONTROL buttons now work for sound adjustments.

- ### 5 Press CONTROL ▼ (or ▲) repeatedly until one of the following indications (with the current setting)\* appears.

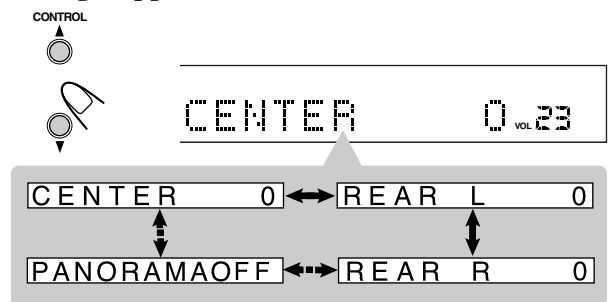

- CENTER** : To adjust the center speaker output level (from -10 to +10).
- REAR L** : To adjust the left rear speaker output level (from -10 to +10).
- REAR R** : To adjust the right rear speaker output level (from -10 to +10).
- PANORAMA control** : Selectable only when "PL II MUSIC" is selected:
  - Select "ON" when you like to enjoy "wraparound" sound effect with side-wall image.
  - Select "OFF" when you like to enjoy originally recorded sound.

\* "0" is the initial setting for the speaker output levels, and "OFF" for Panorama control. If you have already changed the setting, another setting will be shown.



### 6 Press CONTROL ► (or ◀) to make adjustments.

- When adjusting the speaker output levels, make adjustments so that the sound level of the selected speaker is set at the same level as that of the front speakers.

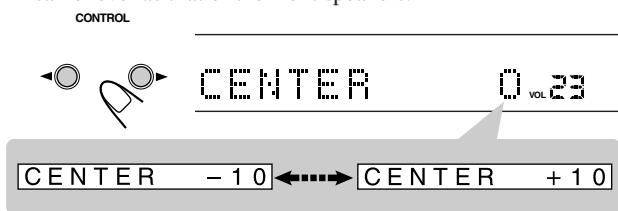

Ex.: When adjusting the center speaker output level.

### 7 Repeat steps 5 and 6 to adjust the other settings.

#### To cancel Surround Mode

Press SURROUND ON/OFF again so that “STEREO” appears on the display.

- If Surround mode is canceled while playing back multichannel digital software, all channel signals are mixed and output through the front speakers (and subwoofer if you have connected a subwoofer and set the subwoofer setting correctly—“YES”).

### Using DAP Modes and All Channel Stereo (Front Panel)

Once you have adjusted the DAP modes and All Channel Stereo, the adjustment is memorized for each source.

- You cannot use the DAP modes and All Channel Stereo if no rear speakers are connected.
- You cannot adjust the effect level for “ALL CH ST.”

### 1 Start playing 2-channel software—either digital or analogue—and select the source.

### 2 Press SURROUND ON/OFF to activate Surround mode.

When Surround mode turns on, the last selected Surround mode will be activated.

- Each time you press the button, Surround mode turns on and off alternately.



### 3 Press SURROUND MODE repeatedly until one of the DAP modes or “ALL CH ST.” you like to apply appears on the display.

The DSP indicator also lights up on the display.

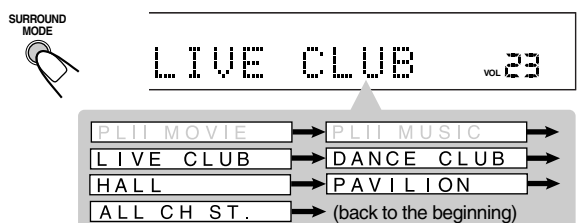

### 4 Press ADJUST.

- The CONTROL buttons now work for sound adjustments.

### 5 Press CONTROL ▼ (or ▲) repeatedly until one of the following indications (with the current setting)\* appears.

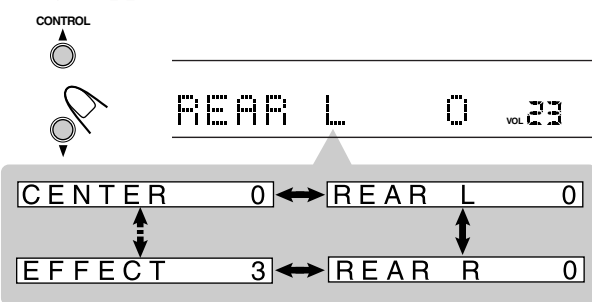

#### CENTER (only for “All CH ST.”):

To adjust the center speaker output level (from -10 to +10).

**REAR L** : To adjust the left rear speaker output level (from -10 to +10).

**REAR R** : To adjust the right rear speaker output level (from -10 to +10).

#### EFFECT (except “All CH ST.”):

To adjust the DAP effect level. As the number increases, the effect becomes stronger (normally set it to “EFFECT 3”).

\* “0” is the initial setting for the speaker output levels, and “EFFECT 3” is for the DAP effect level.

If you have already changed the setting, another setting will be shown.

### 6 Press CONTROL ► (or ◀) to make adjustments.

- When adjusting the speaker output levels, make adjustments so that the sound level of the selected speaker is set at the same level as that of the front speakers.

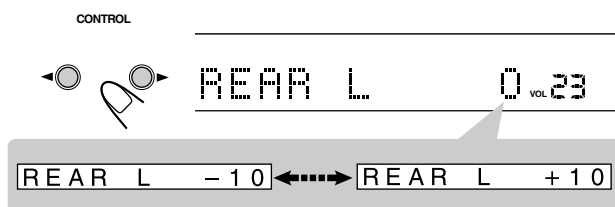

Ex.: When adjusting the left rear speaker output level.

### 7 Repeat steps 5 and 6 to make other adjustments.

#### To cancel DAP Modes and All Channel Stereo

Press SURROUND ON/OFF so that “STEREO” appears on the display. The DSP indicator goes off.

# Mastering Remote Operations

You can use the remote control to operate not only this unit but also other JVC's products.

- Refer also to the manuals supplied for the other products.
  - This remote control can operate a VCR whose remote control code is set to A.
- To operate the other products, aim the remote control directly at the remote sensor on the target product.

## ■ Operating this unit

- **Turning on the power—POWER buttons**  
(see also page 10)

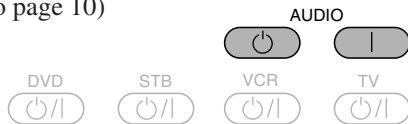

**AUDIO** : Turn off this unit.

**AUDIO** : Turn on this unit.

- **Selecting the source to play—Source selecting buttons** (see also page 10)

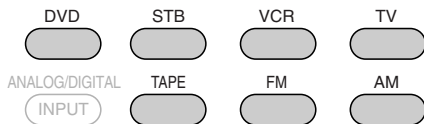

**DVD** : Select the DVD player.

**STB** : Select the STB.

**VCR** : Select the VCR.

**TV** : Select the TV.

**TAPE** : Select the cassette recorder.

**FM** : Select the FM band.

**AM** : Select the AM band.

These buttons also change the functions of the 10 keys, and make them work to operate the target source components. (See the next page.)

- **Adjusting the volume—VOLUME buttons**  
(see also page 10)



Adjust the volume level.

- **Activating TV Direct—TV DIRECT button** (see also page 11)



Activate the TV Direct.

- **Turning off the sound temporarily —MUTING button** (see also page 12)



Turn on or off the sound output.

- **Turning off the power with the Sleep Timer —SLEEP button** (see also page 12)



Set the shut-off time until the unit turns off automatically.

- **Changing the display brightness —DIMMER button** (see also page 12)



Dim or brighten the display illuminations.

- **Selecting the analogue or digital input—ANALOG/DIGITAL INPUT button**  
(see also page 13)

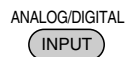

Select either analogue input or digital input for the digital source.

- **Creating realistic sound fields—SURROUND ON/OFF and SURROUND MODE buttons**  
(see also pages 32 – 35)



**SURROUND ON/OFF:**

Turn on or off Surround mode.



**SURROUND MODE:**

Select the Surround modes. Each time you press the button, the Surround modes change.

- **Reinforcing the Bass—BASS BOOST button**  
(see also page 21)

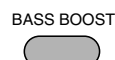

Turn on or off Bass Boost.

- **Adjusting the sound—SOUND, TEST, EFFECT buttons** (see also pages 33 – 35)



**SOUND** : Change the functions of 10 keys, and make them work for sound adjustments.



**TEST** : Turn on or off the test tone output.



**EFFECT** : Change the DAP effect level.

### □ Adjusting the sound and operating tuner —10 keys

■ After pressing **SOUND**, you can use the 10 keys for sound adjustments (see also pages 21, 22, 34, 35).

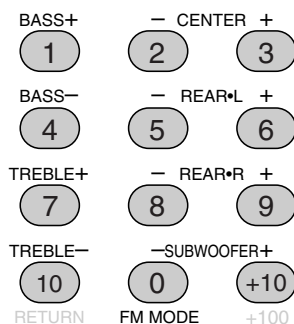

<b>BASS +/-</b>	: Adjust the bass sounds.
<b>TREBLE +/-</b>	: Adjust the treble sounds.
<b>CENTER +/-</b>	: Adjust the center speaker output level.
<b>REAR•L +/-</b>	: Adjust the left rear speaker output level.
<b>REAR•R +/-</b>	: Adjust the right rear speaker output level.
<b>SUBWOOFER +/-</b>	: Adjust the subwoofer level.

■ After pressing **FM** or **AM**, you can use the 10 keys for tuner operations (see also page 25).

<b>1 – 10, +10</b>	: Select a preset channel.
<b>FM MODE (0)</b>	: Change FM mode.

Ex.: Selecting preset FM/AM channel numbers using the 10 keys

- For number 5, press 5.
- For number 15, press +10, then 5.
- For number 30, press +10, +10, then 10.

### □ Tuning in stations manually—**TUNING UP** and **TUNING DOWN** buttons (see also page 23)

After pressing **FM** or **AM**, you can change the frequencies by pressing (and holding) the buttons.

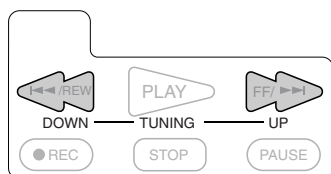

### □ Operating RDS

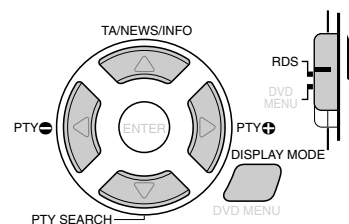

■ After setting **RDS/DVD MENU selector** to “RDS,” you can use the buttons illustrated above for RDS operations (see also pages 26 – 29).

<b>DISPLAY MODE</b>	: Display RDS information.
<b>PTY SEARCH/PTY +/-</b>	: Search for PTY codes.
<b>TA/NEWS/INFO</b>	: Select programs for Enhanced Other Network function.

### ■ Operating other JVC's products

#### □ Turning on the power—**POWER** buttons

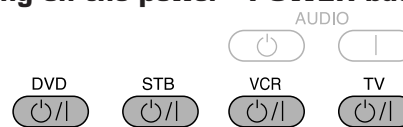

<b>DVD</b>	: Turn on or off a DVD player.
<b>STB</b>	: Turn on or off an STB.
<b>VCR</b>	: Turn on or off a VCR.
<b>TV</b>	: Turn on or off a TV.

#### □ Selecting the channels—10 keys

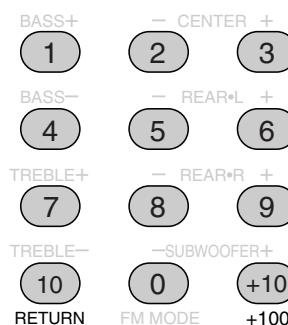

■ After pressing **TV** (source selecting button), you can use the 10 keys for selecting a channel on the TV.

<b>1 – 9, 0, +10 (+100)</b>	: Select a channel.
<b>10 (RETURN)</b>	: Function as the RETURN button.

# Mastering Remote Operations

- After pressing **VCR** (source selecting button) or **VCR CONTROL**, you can use the 10 keys for VCR operations.

	<p>If you use <b>VCR CONTROL</b>, you can change the functions of 10 keys for VCR operations without changing the current source.</p>
---	---

**1 – 9, 0** : Select a channel on the VCR.

- After pressing **STB** (source selecting button), you can use the 10 keys for STB operations.

**1 – 9, 0** : Select a channel.

## Operating other JVC's products—Audio/video operation buttons

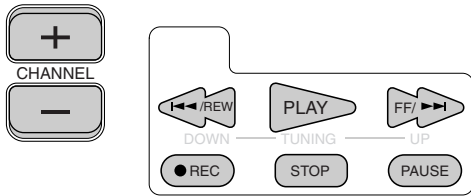

- After pressing **DVD** (source selecting button), you can use the following buttons for DVD operations.

**PLAY** : Start playback.

**STOP** : Stop playback.

**PAUSE** : Pause playback. To release it, press **PLAY**.

**FF** : Skip to the beginning of the next chapter.

**REW** : Return to the beginning of the current (or previous) chapter.

- After pressing **TV** (source selecting button), you can use the following buttons for changing the channels on the TV.

**CHANNEL +/-** : Change channel numbers.

- After pressing **VCR** (source selecting button), you can use the following buttons for VCR operations.

**CHANNEL +/-** : Change channel numbers on the VCR.

**PLAY** : Start playback.

**STOP** : Stop playback or recording.

**PAUSE** : Pause playback. To release it, press **PLAY**.

**FF** : Fast-wind a tape.



**REW** : Rewind a tape.

**• REC** : • Press this button with **PLAY** to start recording.  
• Press this button with **PAUSE** to enter recording pause.

- After pressing **STB** (source selecting button), you can use the following buttons for STB operations.

**CHANNEL +/-** : Change channel numbers on the STB.

- These buttons work only for TV operations.

  	<p><b>TV/VIDEO</b> : Change the input mode (Video input and TV tuner) on the TV.</p> <p><b>TV VOL +/-</b> : Adjust the volume on the TV.</p>
---	--

## Operating DVD menu for JVC's DVD player

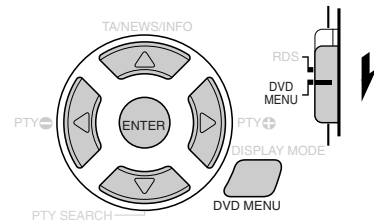

- After setting **RDS/DVD MENU selector** to "**DVD MENU**," you can use the buttons illustrated above for DVD menu operations.

**DVD MENU** : Display or erase the menu screen.

**Δ / ▽ / < / >** : Select an item on the menu screen.

**ENTER** : Enter a selected item.

## ■ Operating other Manufacturers' Equipment

By changing the transmittable signals, you can use the remote control supplied for this unit to operate other manufacturers' equipment.

- Refer also to the manuals supplied for the other products.
- To operate those components with the remote control, first you need to set the manufacturers' codes each for DVD player, STB, VCR, and TV.
- After replacing batteries of the remote control, set the manufacturers' codes again.

### □ Changing the transmittable signals for operating a DVD player

- 1 Press and hold DVD  $\odot/\text{I}$ .
- 2 Press DVD.
- 3 Enter manufacturer's code using buttons 1 – 9, and 0.
- 4 Release DVD  $\odot/\text{I}$ .

Now, you can perform the following operations on the DVD player.

<b>DVD <math>\odot/\text{I}</math></b>	: Turn on or off the DVD player.
<b>PLAY</b>	: Start playback.
<b>STOP</b>	: Stop playback.
<b>PAUSE</b>	: Pause playback. To release it, press <b>PLAY</b> .
<b>▶▶</b>	: Skip to the beginning of the next chapter.
<b>◀◀</b>	: Return to the beginning of the current (or previous) chapter.

#### **Note:**

Refer also to the manual supplied with your DVD player.

After pressing DVD MENU with the RDS/DVD MENU selector set to "DVD MENU," these buttons can be used for the DVD menu operations.

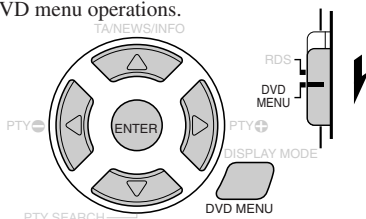

#### **Note:**

For detailed menu operations, refer to the instructions supplied with the discs or the DVD player.

### 5 Try to operate your DVD player by pressing DVD $\odot/\text{I}$ .

When your DVD player turns on or off, you have entered the correct code.

#### Manufacturers' codes for DVD player

Manufacturer	Codes
JVC	01
Panasonic	02
Philips	07
Pioneer	03
Sony	05
Toshiba	04
Yamaha	06

### □ Changing the transmittable signals for operating an STB

- 1 Press and hold STB  $\odot/\text{I}$ .
- 2 Press STB.
- 3 Enter manufacturer's code using buttons 1 – 9, and 0.
- 4 Release STB  $\odot/\text{I}$ .

Now, you can perform the following operations on the STB.

<b>STB <math>\odot/\text{I}</math></b>	: Turn on or off the STB.
<b>CHANNEL +/-</b>	: Change the channels.
<b>1 – 10, 0, +10 (+100)</b>	: Select the channels.

#### **Note:**

Refer also to the manual supplied with your STB.

### 5 Try to operate your STB by pressing STB $\odot/\text{I}$ .

When your STB turns on or off, you have entered the correct code.

If there are more than one code listed for your brand of STB, try each one until the correct one is entered.

#### Manufacturers' codes for STB

Manufacturer	Codes
JVC	01, 02
Amstrad	03 – 06, 33
BT	01
Canal Stellite	22
Canal +	22
D – Box	26
Echostar	19 – 21, 23
Finlux	11
Force	30
Galaxis	29
Grundig	07, 08
Hirschmann	07, 19, 39
ITT Nokia	11
Jerrold	16
Kathrein	13, 14, 36
Luxor	11
Mascom	34
Maspro	13
Nokia	26, 28, 35
Pace	10, 27, 33
Panasonic	15
Philips	09, 25
RFT	12
Saba	37
Sagem	24, 31
Salora	11
Selector	31
Skymaster	12, 38
Thomson	37
TPS	24
Triax	32
Videoway	17, 18
Wisi	07

Manufacturers' codes are subject to change without notice. If they are changed, this remote control cannot operate the equipment.

# Mastering Remote Operations

## ❑ Changing the transmittable signals for operating a VCR

- 1 Press and hold VCR  $\odot/\text{I}$ .
- 2 Press VCR.
- 3 Enter manufacturer's code using buttons 1 – 9, and 0.
- 4 Release VCR  $\odot/\text{I}$ .

Now, you can perform the following operations on the VCR.

VCR $\odot/\text{I}$	: Turn on or off the VCR.
CHANNEL +/-	: Change the channels.
1 – 10, 0, +10 (+100)	: Select the channels.
PLAY	: Start playback.
STOP	: Stop playback or recording.
PAUSE	: Pause playback. To release it, press <b>PLAY</b> .
FF	: Fast-wind a tape.
REW	: Rewind a tape.
• REC	: • Press this button with <b>PLAY</b> to start recording. • Press this button with <b>PAUSE</b> to enter recording pause.

**Note:**

Refer also to the manual supplied with your VCR.

## 5 Try to operate your VCR by pressing VCR $\odot/\text{I}$ .

When your VCR turns on or off, you have entered the correct code.

If there are more than one code listed for your brand of VCR, try each one until the correct one is entered.

Manufacturers' codes for VCR

Manufacturer	Codes
JVC	01
Aiwa	02, 20
Bell+Howell	03, 16
Blaupunkt	04
CGM	03, 05, 16
Daewoo	34
Digital	05
Fisher	03, 16
G.E.	06
Grundig	07
Hitachi	08, 09
Loewe	05, 10, 11
Magnavox	04, 05
Mitsubishi	12 – 15
Nokia	16
Nordmende	17 – 19, 31
Orion	20
Panasonic	21
Philips	05, 22
Phonola	05
Saba	17 – 19, 23, 31
Samsung	24, 25
Sanyo	03, 16
Sharp	26, 27
Siemens	07
Sony	28 – 30, 35
Telefunken	17 – 19, 31, 32
Toshiba	33

## ❑ Changing the transmittable signals for operating a TV

- 1 Press and hold TV  $\odot/\text{I}$ .
- 2 Press TV.
- 3 Enter manufacturer's code using buttons 1 – 9, and 0.
- 4 Release TV  $\odot/\text{I}$ .

Now, you can perform the following operations on the TV.

TV $\odot/\text{I}$	: Turn on or off the TV.
TV VOL +/-	: Adjust the volume.
TV/VIDEO	: Set the input mode (either TV or VIDEO)
CHANNEL +/-	: Change the channels.
1 – 10, 0, +10 (+100)	: Select the channels.

**Note:**

Refer also to the manual supplied with your TV.

## 5 Try to operate your TV by pressing TV $\odot/\text{I}$ .

When your TV turns on or off, you have entered the correct code.

If there are more than one code listed for your brand of TV, try each one until the correct one is entered.

Manufacturers' codes for TV

Manufacturer	Codes
JVC	01
Akai	02, 05
Blaupunkt	03
Daewoo	10, 31, 32
Fenner	04, 31, 32
Fisher	05
Grundig	06
Hitachi	07, 08
Inno-Hit	09
Irradio	02, 05
Magnavox	10
Mitsubishi	11, 33
Miver	03
Nokia	12, 34
Nordmende	13, 14, 18, 26 – 28
Okano	09
Orion	15
Panasonic	16, 17
Philips	10
Saba	13, 14, 18, 26 – 28
Samsung	10, 19, 32
Sanyo	05
Schneider	02, 05
Sharp	20
Sony	21 – 25
Telefunken	13, 14, 18, 26 – 28
Thomson	13, 14, 18, 26 – 28, 30
Toshiba	29

Manufacturers' codes are subject to change without notice. If they are changed, this remote control cannot operate the equipment.

# Troubleshooting

Use this chart to help you solve daily operational problems. If there are any problems you cannot solve, contact your JVC's service center.

PROBLEM	POSSIBLE CAUSE	SOLUTION
The power does not come on.	The power cord is not plugged in.	Plug the power cord into an AC outlet.
No sound from speakers.	Speaker signal cables are not connected.	Check speaker wiring and reconnect if necessary.
	An incorrect source is selected.	Select the correct source.
	Muting is activated.	Press MUTING to cancel the mute.
	An incorrect input mode (analogue or digital) is selected.	Select the correct input mode (analogue or digital).
	Connections are incorrect.	Check connections.
Buttons cannot be used.	TV Direct is activated.	Deactivate TV Direct (see pages 11 and 19).
	TV Direct is activated.	Deactivate TV Direct (see pages 11 and 19).
Sound from one speaker only.	The balance is set to one extreme.	Adjust the balance properly (see page 20).
Continuous hiss or buzzing during FM reception.	Incoming signal is too weak.	Connect an outdoor FM antenna or contact your dealer.
	The station is too far away.	Select a new station.
	An incorrect antenna is used.	Check with your dealer to be sure you have a correct antenna.
	Antennas are not connected properly.	Check connections.
Occasional cracking noise during FM reception.	Ignition noise from automobiles.	Move the antenna farther from automobile traffic.
"OVERLOAD" starts flashing on the display.	Speakers are overloaded because of high volume.	<ol style="list-style-type: none"> <li>1. Press STANDBY/ON <math>\odot</math>/I on the front panel to turn off the unit.</li> <li>2. Stop the playback source.</li> <li>3. Turn on the unit again, and adjust the volume.</li> </ol>
	Speakers are overloaded because of short circuit of speaker terminals.	<p>Press STANDBY/ON <math>\odot</math>/I on the front panel to turn off the unit, then check the speaker wiring.</p> <p>If "OVERLOAD" does not disappear, unplug the AC power cord, then plug it back again.</p> <p>If speaker wiring is not short-circuited, contact your dealer.</p>

TO BE CONTINUED ON THE NEXT PAGE



# Troubleshooting

---

PROBLEM	POSSIBLE CAUSE	SOLUTION
The STANDBY lamp lights up after turning on the power, but soon the unit turns off (into standby mode).	The unit is overloaded because of a high voltage.	Press STANDBY/ON  on the front panel to turn off the unit. After unplugging the power cord, consult your dealer.
Remote control does not operate as you intend.	The remote control is not ready for your intended operation.	Press SOUND or a source selecting button first, then press the buttons you want to use. (See pages 39 and 40.)
Remote control does not work.	There is an obstruction hiding the remote sensor on the unit.	Remove the obstruction.
	Batteries are weak.	Replace batteries.
	RDS/DVD MENU selector is set to the incorrect position.	Set RDS/DVD MENU selector to the proper position.

**Note:**

*When you use the digital coaxial connection, the sounds may be intermitted by the outside noise such as a lightning discharge but they will restore automatically. This is not a malfunction.*

## Amplifier

Output Power	At Stereo operation:	
	Front channels:	60 W per channel, min. RMS, both channels driven into 8 Ω at 1 kHz with no more than 0.9% total harmonic distortion. (IEC268-3/DIN)
	At Surround operation:	
	Front channels:	60 W per channel, min. RMS, driven into 8 Ω at 1 kHz with no more than 0.8% total harmonic distortion.
	Center channel:	60 W, min. RMS, driven into 8 Ω at 1 kHz, with no more than 0.8% total harmonic distortion.
	Rear channels:	60 W per channel, min. RMS, driven into 8 Ω at 1 kHz, with no more than 0.8% total harmonic distortion.

## Audio

Audio Input Sensitivity/Impedance (1 kHz):	DVD, STB, VCR, TV, TAPE:	220 mV/47 kΩ
Audio Input (DIGITAL IN)* :	Coaxial: DIGITAL 1 (DVD):	0.5 V(p-p)/75 Ω
	Optical: DIGITAL 2 (STB):	-21 dBm to -15 dBm (660 nm ±30 nm)
	*Corresponding to Linear PCM, Dolby Digital, and DTS Digital Surround (with sampling frequency—32 kHz, 44.1 kHz, 48 kHz).	
Audio Output Level:	VCR, TV, TAPE:	220 mV
Signal-to-Noise Ratio (*66 IHF/DIN):	DVD, STB, VCR, TV, TAPE:	87 dB/62 dB
Frequency Response (8 Ω):	DVD, STB, VCR, TV, TAPE:	20 Hz to 20 kHz (±1 dB)
Tone Control:	Bass (100 Hz):	±10 dB
	Treble (10 kHz):	±10 dB
Bass Boost:	+6 dB ± 1 dB at 70 Hz	

## Video

Video Input Sensitivity/Impedance (1 kHz):		
Composite video:	DVD, STB, VCR, TV:	1 V(p-p)/75 Ω
S-VIDEO:	DVD, STB, VCR:	(Y:luminance): 1 V(p-p)/75 Ω
		(C:chrominance): 0.286 V(p-p)/75 Ω
RGB:	DVD, STB, VCR:	0.7 V(p-p)/75 Ω
Video Output Level/Impedance (1 kHz):		
Composite video:	VCR, TV:	1 V(p-p)/75 Ω
S-VIDEO:	TV:	(Y:luminance): 1 V(p-p)/75 Ω
		(C:chrominance): 0.286 V(p-p)/75 Ω
RGB:	TV:	0.7 V(p-p)/75 Ω
Signal-to-Noise Ratio (S/N):	45 dB	
Synchronize:	Negative	

TO BE CONTINUED ON THE NEXT PAGE

# Specifications

---

## **FM tuner (IHF)**

Tuning Range:	87.50 MHz to 108.00 MHz	
Usable Sensitivity:	Monaural:	17.0 dBf (1.95 $\mu$ V/75 $\Omega$ )
50 dB Quieting Sensitivity:	Monaural:	21.3 dBf (3.2 $\mu$ V/75 $\Omega$ )
	Stereo:	41.3 dBf (31.5 $\mu$ V/75 $\Omega$ )
Signal-to-Noise Ratio (IHF-A weighted):	Monaural:	78 dB at 85 dBf
	Stereo:	73 dB at 85 dBf
Total Harmonic Distortion:	Monaural:	0.4% at 1 kHz
	Stereo:	0.6% at 1 kHz
Stereo Separation at REC OUT:	35 dB at 1 kHz	
Alternate Channel Selectivity:	60 dB: ( $\pm$ 400 kHz)	

## **AM (MW/LW) tuner**

Tuning Range:	MW:	522 kHz to 1 629 kHz
	LW:	144 kHz to 288 kHz
Usable Sensitivity:	Loop antenna:	400 $\mu$ V/m (MW)
Signal-to-Noise Ratio:	50 dB (100 mV/m)	

## **General**

Power Requirements:	AC 230V $\sim$ , 50 Hz
Power Consumption:	130 W (at operation)
	2 W (in standby mode)
Dimensions (W x H x D):	435 mm x 103 mm x 398 mm
	(17 <sup>3</sup> / <sub>16</sub> in. x 4 <sup>1</sup> / <sub>16</sub> in. x 15 <sup>1</sup> / <sub>16</sub> in.)
Mass:	7.4 kg (16.4 lbs)

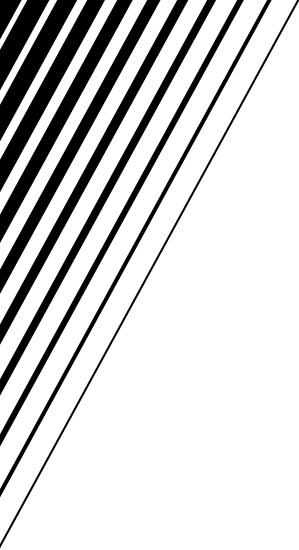

**JVC**  
VICTOR COMPANY OF JAPAN, LIMITED